

TROW & HOLDEN

---

STONE  
CUTTING  
TOOLS

---

MADE TO LAST SINCE 1890



IN BARRE, VERMONT USA

---



## Handmade in Vermont.

At Trow & Holden Company, we are proud to offer the highest quality and widest variety of stoneworking tools available anywhere. Since 1890, we have worked side by side with the highly skilled people who use our tools — refining their design, improving materials and processes and exploring new applications. We believe this long tradition of working closely with our customers is instrumental in keeping us innovative. The best designs come from the users of our tools and, because we make everything right here, we can respond quickly to a customer's particular need. It's not unusual for a tool we custom-fabricated to end up in our next catalog.

From forging and forming to heat treatment and finish grinding, all our tools are made on the same site in Barre, Vermont where they have been manufactured for more than 130 years. Our production employees complete a four-year apprenticeship in tool making — we like to say that our tools are “made by artisans for artisans.”

We manufacture a broad range of carbide-tipped hand tools and hammers used by stonemasons throughout the world as well as a complete line of very precise pneumatic tools and chisels for stone carving. Our company was among the very first to successfully use tungsten carbide tips on hand tool and hammer blades. Since then, we have continued to be at the forefront in carbide material development. All of our Hand Tools, Pneumatic Tools and Hammers are individually serial-numbered allowing us to record and keep track of the physical specifications, purchase information and performance of every tool we make. And we are proud to note that we received our ISO 9001 certification as of June, 2018.

Trow & Holden grew out of a granite industry that has thrived in Barre for almost 200 years, but as we expand to serve customers worldwide, we have broadened our selection to include tools for softer stone and more specialized uses. We are grateful to our partners in the field who have helped us develop our new tool lines.

If you have questions or suggestions regarding any of our products, call us at **1-800-451-4349** or visit our website at [www.trowandholden.com](http://www.trowandholden.com). Also, please feel free to visit our factory, weekdays from 8 a.m.–4 p.m. — we'd love to show you around and will do our best to help you choose the right tool for your purpose.

Trow & Holden has been a family business from the start, and I feel so fortunate that my brother Ben and I are able to carry on the family tradition. When we purchased the company from our parents Norm and Lauren in 2018, we never could have anticipated what the next three years would bring. Like many others, we have faced economic uncertainty, supply chain and materials disruption, and the challenges of operating in a global marketplace. But Trow & Holden is steeped in history, and that history makes us strong. If you walk through our building, you can follow the story of the company and the people who have made it great from the very beginning. This is a company that has survived for more than 130 years — through pandemics, wars, booms and depressions — and I am not surprised that we have continued to endure and even thrive through our current history in the making. We have a team here that takes great pride in what we do, and we have a product that is designed and built to last. I know we all look forward to continuing our long tradition of manufacturing excellence and exceptional customer service into the future.

Sincerely,

Gina Akley, President  
Trow & Holden Company, Inc.



First row: *Jordan, Vice President; Ryan, Walter, Tom and Jonathan, Toolmakers; Chris, Shipper; Lauren, Vice President.*  
Second row: *Chris, Facilities; Benjamin, Owner & General Counsel; Kurt, Toolmaker; Gina, Owner & President; Jack and John, Toolmakers; Henry, Sales & Product Development; David, General Manager; Josh and Brian, Toolmakers; Norm, President Emeritus.*

Tool Groupings ..... 1

Pneumatic Carving Tools

- Pneumatic Hammers ..... 4
- Carbide Chisels for Pneumatic Hammers ..... 6
- Bantam Chisels ..... 9
- Bushing Chisels ..... 10
- Mortar Removal Tools ..... 12
- Pneumatic Tool Accessories ..... 13

Hand Tools

- Carbide Hand Tools ..... 16
- Steel Hand Tools ..... 22
- Tools for Thin Stone ..... 24
- Hand Tool Accessories ..... 25
- Hammers ..... 26
- Tool Maintenance ..... 33
- Replacement Hammer Handles ..... 33
- Tools for Fossil Hunting ..... 34
- Tools for Rockhounding ..... 36
- Tools for Limestone ..... 37

Specialty Equipment

- Splitting Equipment ..... 38
- Heavy Duty Drills & Hammers ..... 39

Accessories & Apparel ..... 40

Warranty & Customer Service ..... inside back cover

## A WORD ABOUT OUR CATALOG

We offer the most rugged, versatile and cost-effective tools of the trade. Our tools are used for a variety of applications.

In an effort to help you determine which tools will suit your purpose, we have shown some general tool groupings on this page and the following two pages.

The tool sets shown throughout the catalog will get you off to a good start — whether you are just beginning to acquire tools, or wish to round out your collection.

*Drawings by Carl Hinsman.*

**Trow & Holden Co. tools are unconditionally guaranteed against defects in manufacturing or materials.** For more information, see inside back cover.

## TROW & HOLDEN CARVING TOOLS FOR GRANITE & HARD STONE

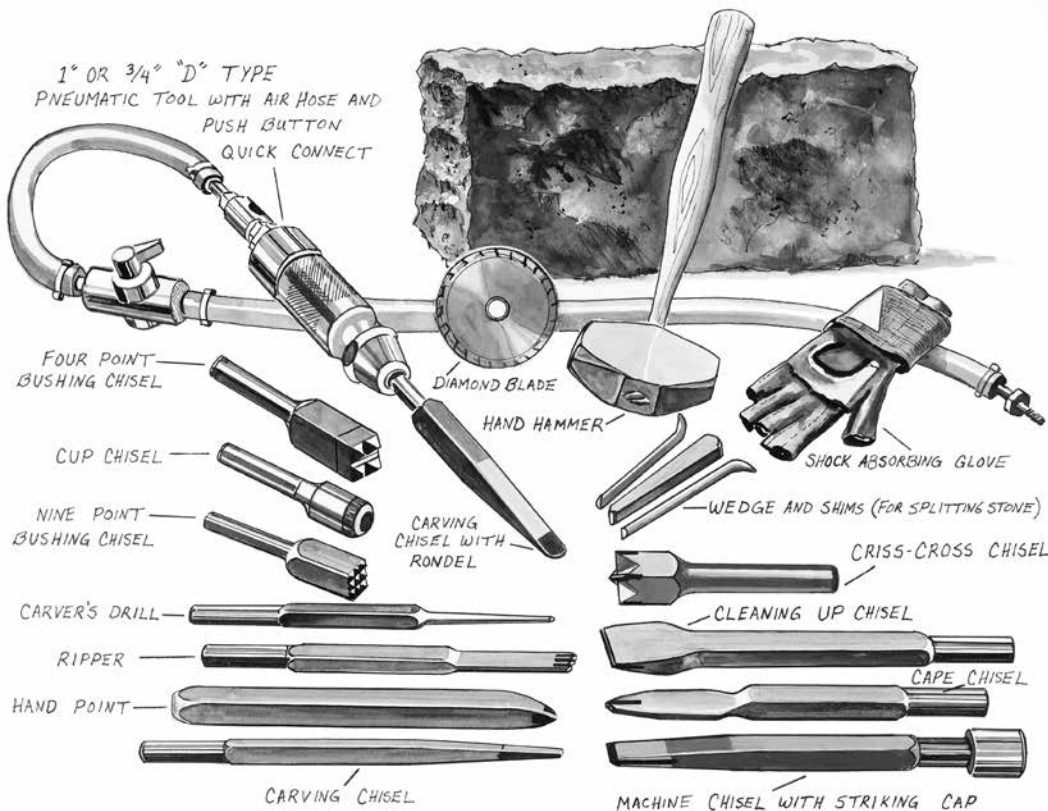

While it is true that granite carves differently from marble or other stones, it also provides distinct advantages. Granite does not bruise, so it is possible to rough out closer to your finish dimensions. It is also possible to achieve a variety of interesting surface finishes by using various bushing tools.

Use flat or rondel chisels — never tooth chisels — when carving granite. We also recommend carbide-tipped tools, since steel chisels will require frequent grinding and retempering when used on granite. Consider using a "Dallett" or Type D pneumatic hammer if you do much of your work in granite. It has more impact than the Type B tool and will save time, particularly when roughing out.

## TROW & HOLDEN CARVING TOOLS FOR MARBLE & SOFT STONE

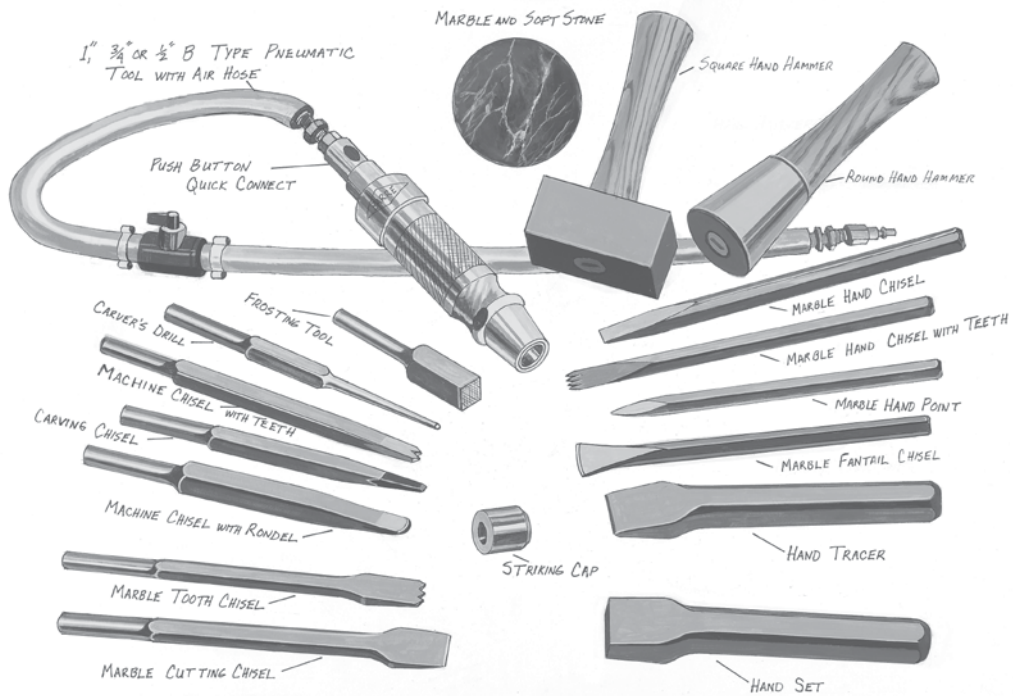

Although there is a crossover between granite and marble tools, certain tool qualities are particularly well-suited to softer stone. Softer stone can be gouged, which makes a tooth chisel an appropriate roughing-out tool. Because the stone is not brittle, blades and teeth can be kept fairly sharp without as much risk of breakage. Both carbide-tipped and steel tools are appropriate for working softer stone. Carbide will last longer and require less maintenance (see Tech Tip on page 8).

Our Marble Cutting Chisels and Tooth Chisels are made out of lighter stock sizes, resulting in significant weight reduction. This allows you to use our smaller pneumatic hammers to drive our wider blade chisels.

Choose a "Type B" or short-stroke pneumatic hammer when working in softer stone. With their lighter impact, these carving tools will have less tendency to "bruise" your stone.

## TROW & HOLDEN HAND TOOLS FOR STONE MASONRY

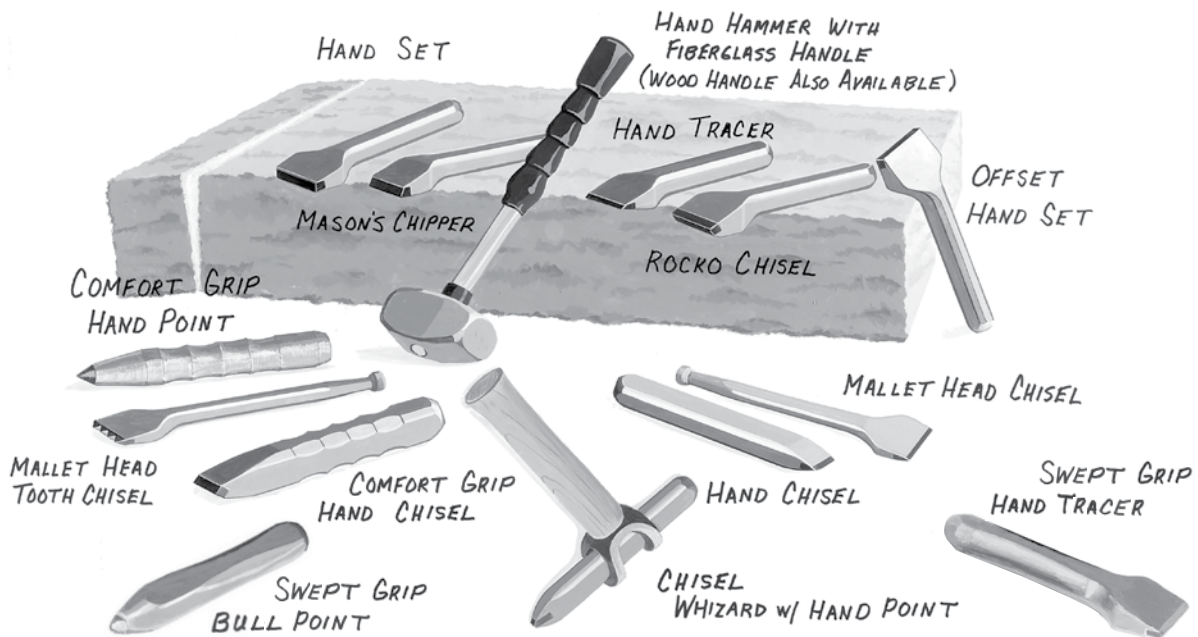

Splitting, trimming and shaping stone can speed up stone masonry projects, whether dry stone or mortar construction. Hand tools or hammers used to split or trim will leave a natural rockface that will become more beautiful over time. Hardened steel blades are suitable for softer

stone or light-duty use. Used on hard stone, carbide-tipped tools will maintain their shape and require less maintenance. Call us to discuss specific applications or for more information on choosing the right tool for your job.

## TROW & HOLDEN HAMMERS FOR STONE MASONRY

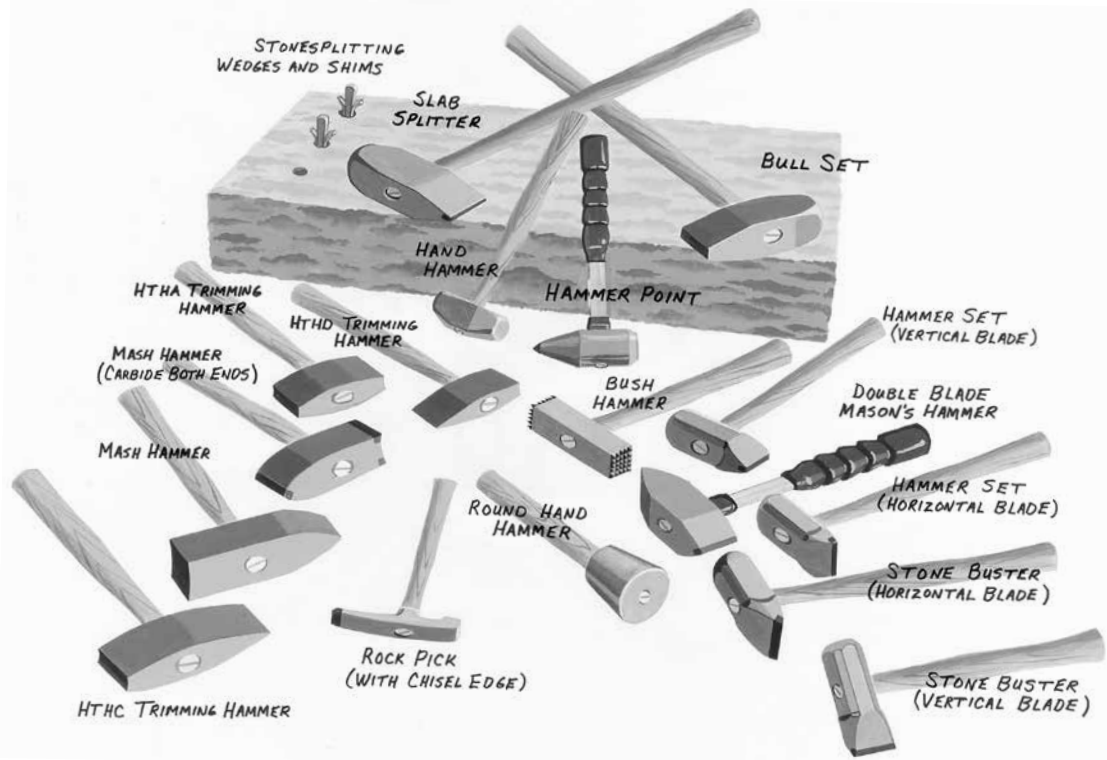

Our remarkable selection of stoneworking hammers allows you to choose from the widest variety of styles and sizes available anywhere in the world. Some hammers offer a choice of carbide or steel blades; choose

a carbide blade hammer when working with very hard or abrasive stone for better performance with less maintenance. Be sure to read our **Trow & Holden Guide to Hammers** for specific uses of each hammer.

## TROW & HOLDEN TOOLS FOR MORTAR REMOVAL

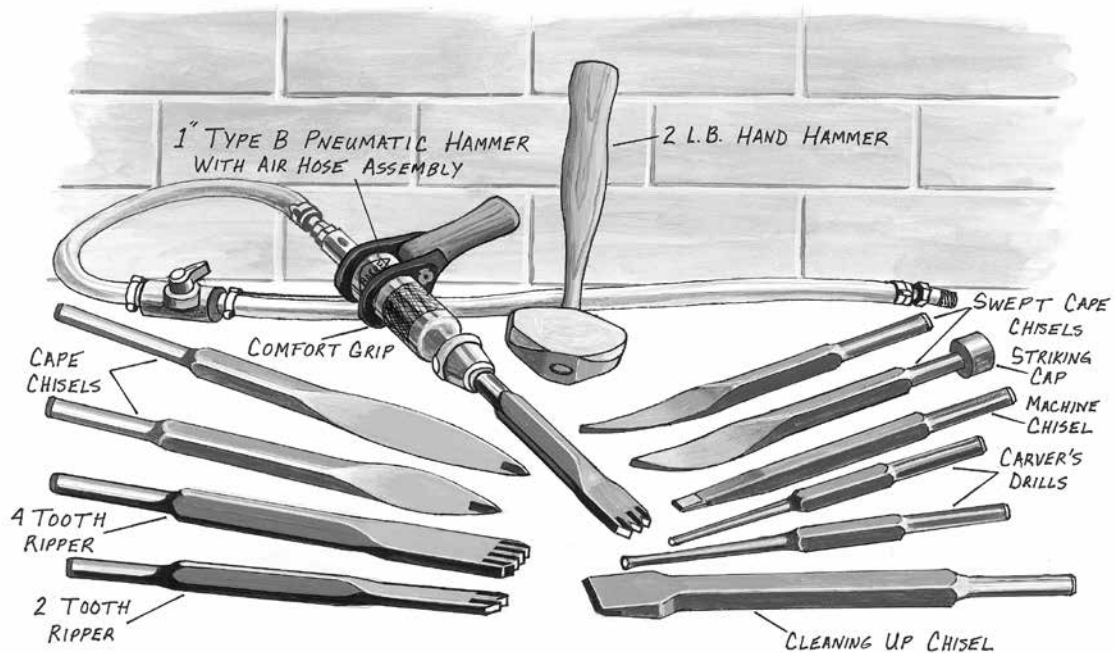

Because they were originally designed for stone sculpture, Trow & Holden pneumatic tools are ideally suited to the delicate task of removing old mortar from masonry buildings prior to repointing. Shown here are some

tools most frequently used for this, including some that were specifically designed for mortar removal. Please call for a written guide to using Trow & Holden tools for mortar removal and masonry restoration.

# PNEUMATIC HAMMERS

With their versatility and wide range of power, our air hammers are suited to many applications, from material removal in granite to detail carving in alabaster. They can also be used to rough out raw timber, remove aging mortar, re-dress millstones and for various other unique applications. Use with an air control valve for maximum precision.

All Trow & Holden air hammers are made to exacting specifications and are guaranteed to deliver reliable performance while providing superior control and efficiency.

## BARRE SHORT STROKE PNEUMATIC HAMMERS: TYPE B

The "TYPE B" is designed to run smoothly at all power levels. Available in Bantam, 1/2", 3/4" and 1" sizes; all are able to provide excellent power for heavier work yet still run smoothly at low power for fine work. Short stroke hammers are often preferred for carving in softer stone. All sizes also have a shaped fingergrip for comfort and ease of control.

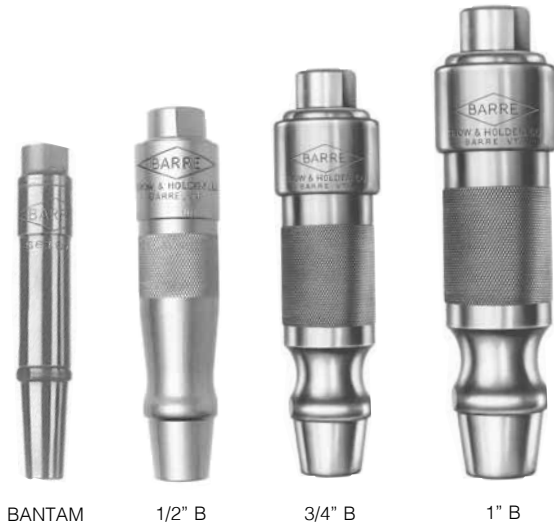

BANTAM

1/2" B

3/4" B

1" B

SPECIFICATIONS	SIZES			
	BANTAM	1/2" B	3/4" B	1" B
Diameter of piston	15/32"	1/2"	3/4"	1"
Outside diameter	7/8"	1-1/4"	1-1/2"	1-5/8"
Length overall	5"	5-3/4"	6-3/4"	7-1/2"
Weight - lbs.- oz.	0-9	1-8	2 -12	3-8
Shank size	5/16"	1/2"	1/2"	1/2"
Air consumption in cu. ft.	3	4	4	6

## THE BARRE "DALLETT-STYLE" PNEUMATIC HAMMERS: TYPE D

The BARRE "TYPE D" tools provide the maximum power per size ratios available anywhere. By using a longer stroke than our other pneumatic hammer, the TYPE D strikes a harder blow over the full power range, making it especially suited for harder stones such as granite or basalt. Its simple design and rugged construction afford reliable and economical operation on the most demanding work. The 1" and 1-1/4" sizes are suitable for larger roughing applications and offer a shaped fingergrip for greater control and comfort during extended use. The 1/2" and 3/4" sizes are perfect for finer jobs where detail and precision are required.



1/2" D

3/4" D

1" D

1-1/4" D

SPECIFICATIONS	SIZES			
	1/2" D	3/4" D	1" D	1-1/4" D
Diameter of piston	9/16"	3/4"	1"	1-1/4"
Outside diameter	1-1/8"	1-5/16"	1-11/16"	2"
Length overall	5-3/4"	6-3/4"	7-7/8"	8-3/4"
Weight - lbs.- oz.	1-4	1-14	3-8	5-10
Shank size	1/2"	1/2"	1/2"	5/8"
Air consumption in cu. ft.	3	4	6	8

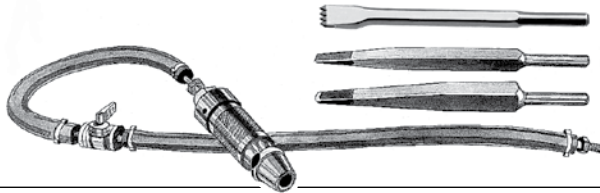

## OUR AIR-POWERED CARVING SET

Stone carving can be slow-going! Improve speed and precision while reducing fatigue with our Air-Powered Carving Set. Add a compressor and you'll have everything you need to get started.

- **Trow & Holden Short Stroke Type B Pneumatic Hammer** with your choice of 1/2" or 3/4" size piston
- **10' air hose** with all connecting hardware installed
- **Three solid carbide Trow & Holden Carving Chisels** – 1/2" straight blade, 5/8" rondel blade, 3/4" tooth chisel
- **Canvas Tool Wrap** for easy storage

## ABOUT PNEUMATIC CARVING HAMMERS

Trow & Holden air hammers are manufactured in two styles, each with a variety of piston sizes, so you will have the ideal range of power in-hand for your work.

The "Type D" or Dallett-style air hammers have a longer stroke and more aggressive action to deliver greater impact across their full range of power. This makes them ideal for use on the hardest types of stone or when more aggressive material removal is required.

The "Type B" air hammers have a shorter, faster stroke, delivering a smoother action that can be utilized to remove material in more even, shallow passes. These air hammers are generally ideal for use on softer types of stone and finish work.

### Air Consumption

Use the air consumption figures given for each pneumatic hammer to determine what size compressor you will need. You may want to purchase a compressor with greater output and air storage capacity if you plan to operate multiple air hammers, or other high-demand pneumatic tools, such as grinders and drills. Please feel free to consult us for help with air compressor selection.

Remember, **always wear safety glasses** when using any stoneworking tool!

### "TYPE B" - SHORT STROKE

- Quieter
- Less vibration
- Shaped fingergrrips in all sizes
- Available in four piston sizes



### "TYPE D" - LONG STROKE

- More impact for quick removal of stone
- More powerful for work with harder stone, especially granite
- Available in four piston sizes

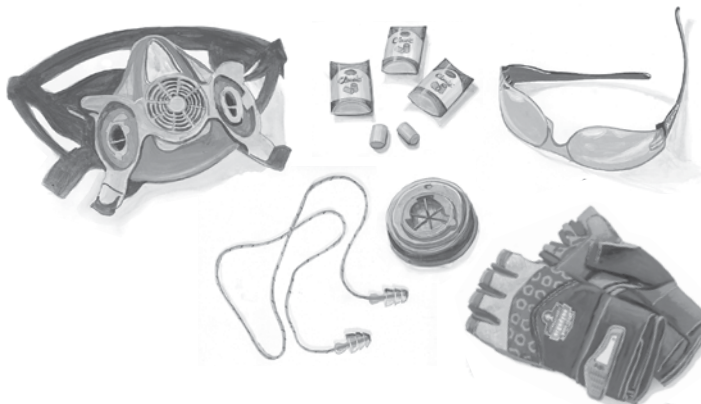

## AIR HAMMER SAFETY SET

Customer safety is our top priority, so we have made it easier by assembling this set, which includes:

- **One pair of reusable ear plugs** and a few pair of disposable ear plugs, just in case
- **Advantage respirator**, which offers protection from stone dust (extra pair of replacement filters included)
- **Safety glasses**
- **Ergodyne half-finger anti-vibration gloves** — please specify glove size when ordering

# CARBIDE CHISELS FOR PNEUMATIC HAMMERS

Trow & Holden proudly manufactures a wide variety of pneumatic stoneworking chisels for use in our pneumatic hammers. Whether you are texturing a large surface area or carving delicate features, removing mortar before repointing a building or re-dressing a millstone, you are sure to find a chisel that is perfect for your work. If not, talk to us! There is a good chance we can fabricate a tool that will meet your needs.

The majority of our pneumatic hammers require chisels with a 1/2" round shank. Our 1-1/4" Type D air hammer requires 5/8" round shanks. The Bantam hammer requires 5/16" shanks. Stock size refers to the thickness of the raw material and affects the weight and bulk of the chisel.

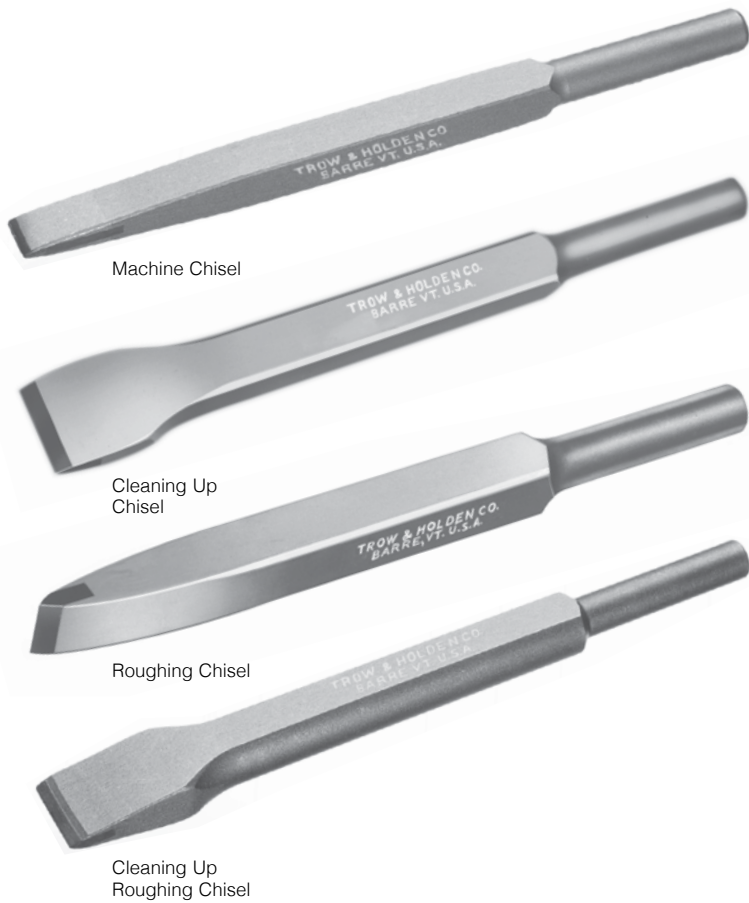

## MACHINE CHISELS

Machine Chisels are used on all types of stone for carving, lettering and general stone removal. Use a Roughing Chisel for heavy duty removal. Cleaning Up Chisels have a heavier stock and wider blade. Also available with teeth or rondel blade. See below for tooth styles.

MACHINE CHISELS	STOCK	SHANK	WIDTH OF BLADE
CC1212F18	1/2"	1/2"	1/8"
CC1212F316	1/2"	1/2"	3/16"
CC1212F14	1/2"	1/2"	1/4"
CC1212F38	1/2"	1/2"	3/8"
CC1212F12	1/2"	1/2"	1/2"
CC5812F58	5/8"	1/2"	5/8"
CC5858F58	5/8"	5/8"	5/8"
CC3412F34	3/4"	1/2"	3/4"
CC3458F34	3/4"	5/8"	3/4"

## CLEANING UP CHISELS

CF1212F1	1/2"	1/2"	1"
CF5812F1	5/8"	1/2"	1"
CF5812F114	5/8"	1/2"	1-1/4"
CF5812F112	5/8"	1/2"	1-1/2"
CF5812F2	5/8"	1/2"	2"

## ROUGHING CHISELS

CC1212R12	1/2"	1/2"	1/2"
CC5812R58	5/8"	1/2"	5/8"
CC5858R58	5/8"	5/8"	5/8"
CC3412R34	3/4"	1/2"	3/4"
CF5812R1	5/8"	1/2"	1"
CF5812R114	5/8"	1/2"	1-1/4"
CF5858R1	5/8"	5/8"	1"
CF5858R114	5/8"	5/8"	1-1/4"

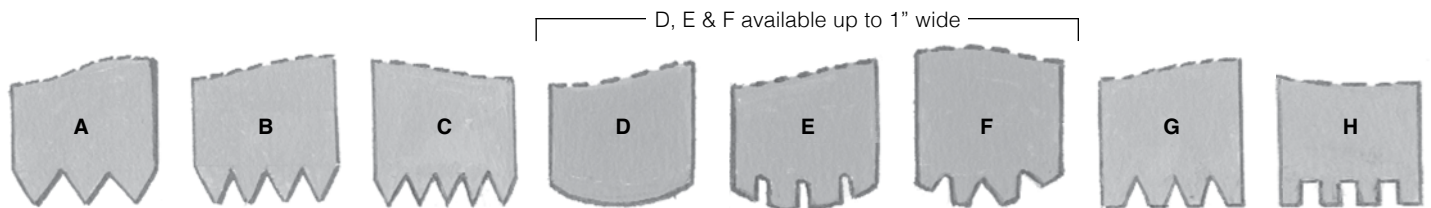

Teeth shown on actual size 3/4" blade. Tooth sizes may vary slightly on wider blades.  
Tooth chisels not recommended for use on granite.

Teeth are cut to order. There is a 25% re-stocking fee on returned tooth chisels except when purchased as part of a tool set.



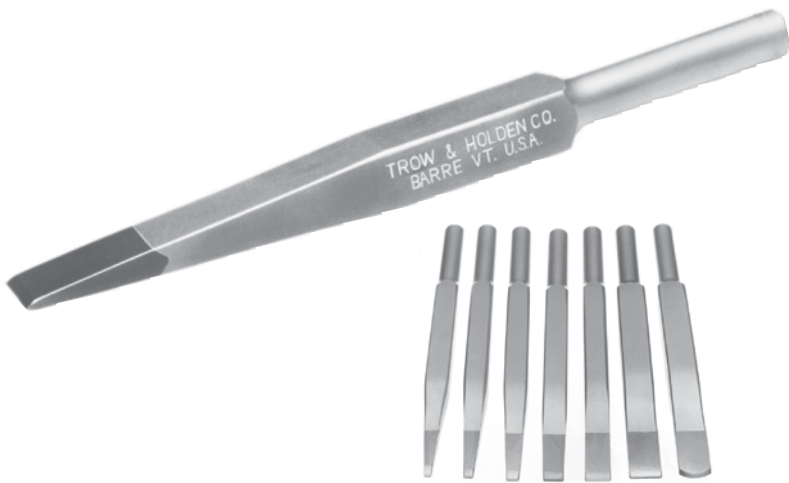

## CARVING CHISELS

Made exclusively by Trow & Holden Company, our Carving Chisels are the same size and shape as traditional machine chisels but feature an elongated carbide tip with three times more carbide, so they will last longer and require less maintenance. Available in straight or rondel styles up to 3/4" wide.

	STOCK	SHANK	WIDTH OF BLADE
<b>CC1212F18NS</b>	1/2"	1/2"	1/8"
<b>CC1212F316NS</b>	1/2"	1/2"	3/16"
<b>CC1212F14NS</b>	1/2"	1/2"	1/4"
<b>CC1212F38NS</b>	1/2"	1/2"	3/8"
<b>CC1212F12NS</b>	1/2"	1/2"	1/2"
<b>CC5812F58NS</b>	5/8"	1/2"	5/8"
<b>CC3412F34NS</b>	3/4"	1/2"	3/4"

## MARBLE CUTTING CHISELS

A lighter weight chisel designed for use on marble and softer stone. Use the tooth chisels for roughing out or texturing. Available in flat, rondel or tooth blades.\*

	STOCK	SHANK	WIDTH OF BLADE
<b>CMC#34-12</b>	1/2"	1/2"	3/4"
<b>CMC#1-12</b>	1/2"	1/2"	1"
<b>CMC#114-12</b>	1/2"	1/2"	1-1/4"
<b>CMC#112-12</b>	1/2"	1/2"	1-1/2"
<b>CMC#2-12</b>	1/2"	1/2"	2"
<b>CMC#212-12</b>	1/2"	1/2"	2-1/2"
<b>CMC#3-12</b>	1/2"	1/2"	3"

## LIMESTONE MACHINE CHISELS

Our redesigned Limestone Chisels feature finely-tapered blades that are sharpened for use on limestone or other soft stone. Steel blades are available in tooth or rondel styles.\* Not recommended for use on hard stone.

CARBIDE	STOCK	SHANK	WIDTH OF BLADE	STEEL
<b>CL5812L34</b>	5/8"	1/2"	3/4"	<b>AL5812L34</b>
<b>CL5812L1</b>	5/8"	1/2"	1"	<b>AL5812L1</b>
<b>CL5812L112</b>	5/8"	1/2"	1-1/2"	<b>AL5812L112</b>
<b>CL5812L2</b>	5/8"	1/2"	2"	<b>AL5812L2</b>

\* To order tooth chisels, determine what size blade you would like and after it place the letter of the tooth style you want.



## MILLSTONE DRESSING SET

This tool set makes millstone maintenance easy and efficient. Originally designed for sculptors, our air hammers and carbide chisels are delicate enough to refurbish fragile, historic stones, but durable enough to perform maintenance and dressing tasks. Includes:

- 1" Trow & Holden Type B Short Stroke Pneumatic Hammer
- 10' air hose with all connecting hardware installed, including male and female Staubli Quick Connects
- 1" Carbide Cleaning Up Chisel, 1" square 25-Point Bushing Chisel and 1/2" Carbide Machine Chisel
- Swivel Retainer and Striking Cap

## CARVER'S DRILLS

Rotate gently between your fingers while your pneumatic hammer provides the impact to drill holes up to 1/2" in depth in your material. Smaller sizes are perfect for detail carving.

	STOCK	SHANK	WIDTH OF BLADE
CE121218	1/2"	1/2"	1/8"
CE1212316	1/2"	1/2"	3/16"
CE121214	1/2"	1/2"	1/4"
CE121238	1/2"	1/2"	3/8"
CE581212	5/8"	1/2"	1/2"

## MACHINE POINTS

Use with a pneumatic hammer to rough out stone and knock off high points. Please specify shank size.

	STOCK	SHANK
CMP12	1/2"	1/2" only
CMP58	5/8"	1/2" or 5/8"
CMP34	3/4"	1/2" or 5/8"

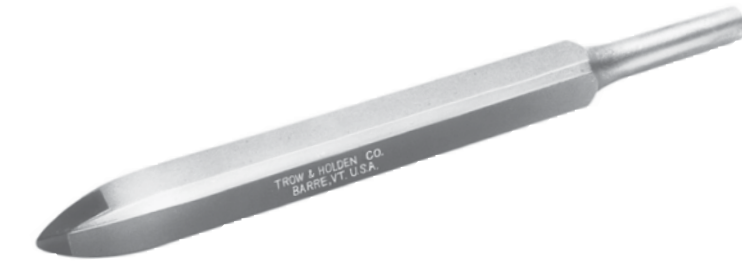
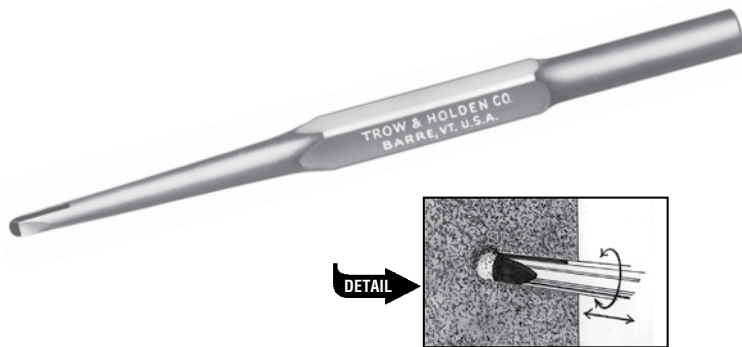

### TROW & HOLDEN TECH TIP

## CARBIDE TOOL CARE

Good maintenance of your carbide chisels lets you cut faster and more accurately. However, improper grinding can damage the carbide and cause tool failure. To extend the life of your chisel:

- Make sure your chisel comes in full contact with the stone and does not wobble on a high spot. Cornering will cause breakage.

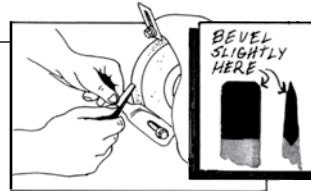
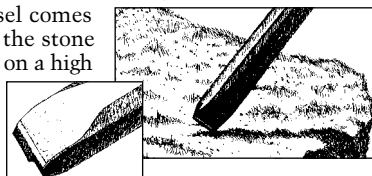

- When grinding, leave corners slightly beveled. Very sharp or pointed carbide may break on harder stones. Use an 80 grit silicon carbide (green) wheel or a diamond polishing disc to sharpen carbide.
- Don't forget to grind the shank end or striking head frequently to maintain the correct "as-new" shape for safe performance.

- Use care when storing or transporting carbide tools. Although tough and durable, carbide can break, especially when struck by another carbide tool.

- Never quench your carbide tool after grinding. Sudden changes in temperature can cause cracking or chipping of the tip, so always air-cool your tool after grinding.



# BANTAM CHISELS

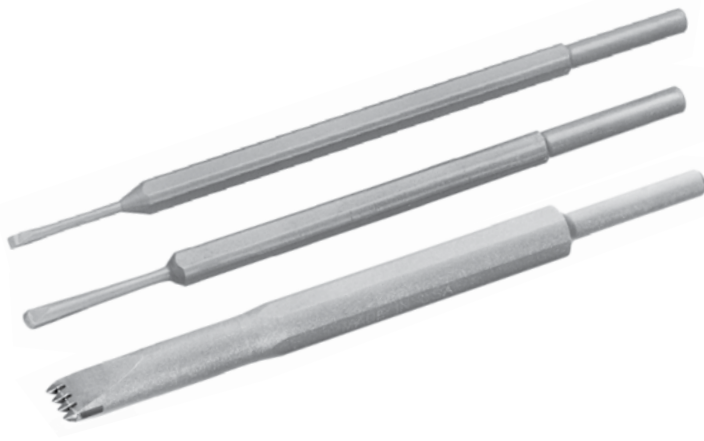

## CARBIDE CHISELS FOR BARRE BANTAM

	SHANK	WIDTH OF BLADE
<b>CC18</b>	5/16"	1/8"
<b>CC316</b>	5/16"	3/16"
<b>CC14</b> (not shown)	5/16"	1/4"
<b>CC38</b> (not shown)	5/16"	3/8"
<b>CC12</b>	5/16"	1/2"

3/16" and 1/4" chisels available with rondel blades.  
1/2" and 3/8" chisels available with teeth or rondel.

All Chisels with 5/16" shanks are designed for use in the Barre Bantam Pneumatic Hammer. Use a Shank Adaptor (page 13) when working with pneumatic hammers that require 1/2" shanks. However, Bantam Chisels should not be adapted for use in large or aggressive pneumatic tools.

## CARBIDE BUSHING CHISELS & WOOD CHISEL ADAPTOR FOR BARRE BANTAM

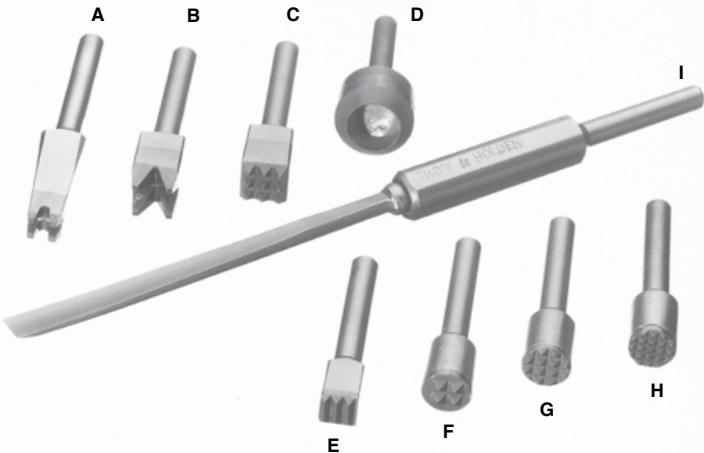

	ITEM NUMBER	DESCRIPTION
A	<b>CBJ-4</b>	3/8" square 4-PT Bush
B	<b>CJ12516-4*</b>	1/2" square Heavy 4-PT Bush
C	<b>CJ12516-9*</b>	1/2" square Heavy 9-PT Bush
D	<b>CCC78516*</b>	7/8" round Cup Chisel
E	<b>CBJ-3</b>	3-Blade Bush
F	<b>CBM-4</b>	4-Tooth Frosting
G	<b>CBM-12</b>	12-Tooth Frosting
H	<b>CBM-21</b>	21-Tooth Frosting
I	<b>S-WOOD</b>	Bantam Wood Chisel Adaptor**

\* Also available as Bushing Set, see page 11.  
\*\* Wood chisel not included.

## TROW & HOLDEN BARRE BANTAM DETAIL CARVING SET | A Great Value!

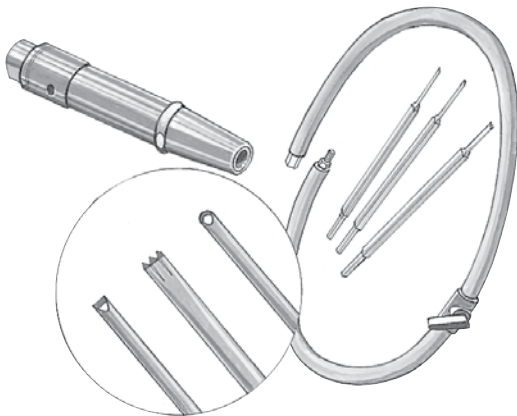

### THE BARRE BANTAM SET

At only 9 ounces, The Barre Bantam is our lightest air hammer for stone carving — less than half the weight of our 1/2" B tool. Like our other air hammers, it offers smooth action with a wide power range for incredible comfort and versatility. Our 5/16" shank carbide chisels are smaller, lighter, and easier to control for fine carving. Set includes:

- Barre Bantam Pneumatic Hammer
- 10' air hose with all hardware installed
- 1/8" Flat Chisel, 3/16" Rondel Chisel, and 1/2" Tooth Chisel

# BUSHING CHISELS

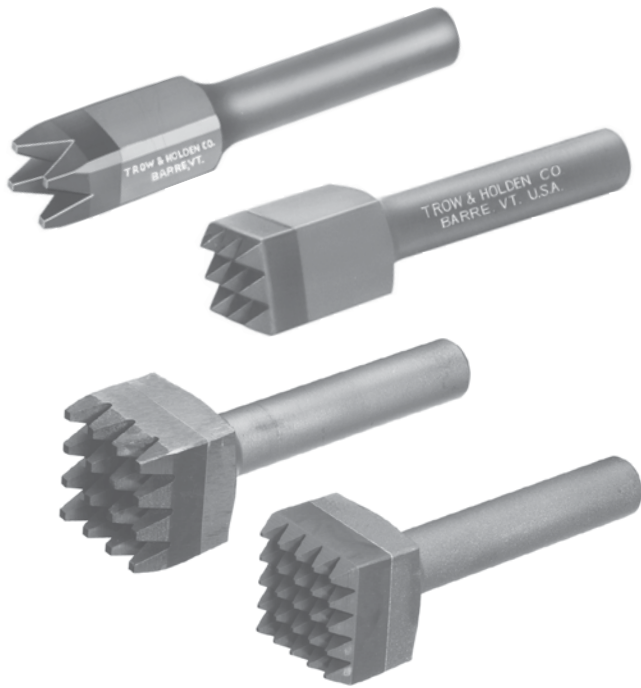

## BUSHING CHISELS WITH TEETH

Pneumatic Bushing Chisels can be utilized for roughing out or texturing. Standard Bushing Chisels are 3-3/4" long, but they are also available in longer lengths for hard-to-reach surfaces. See the Tech Tip below for more information about chisel selection and technique.

4-POINT	STOCK	SHANK	9-POINT
<b>CJ3812-4</b>	3/8"	1/2"	-
<b>CJ1212-4</b>	1/2"	1/2"	<b>CJ1212-9</b>
<b>CJ5812-4</b>	5/8"	1/2"	<b>CJ5812-9</b>
<b>CJ5858-4</b>	5/8"	5/8"	<b>CJ5858-9</b>
<b>CJ3412-4</b>	3/4"	1/2"	<b>CJ3412-9</b>
<b>CJ3458-4</b>	3/4"	5/8"	<b>CJ3458-9</b>
<b>CI1212-4-L (7-3/4")</b>	1/2"	1/2"	<b>CI1212- 9-L (7-3/4")</b>
<b>CI5812-4-L (7-3/4")</b>	5/8"	1/2"	<b>CI5812- 9-L (7-3/4")</b>
<b>CI3412-4-L (7-3/4")</b>	3/4"	1/2"	<b>CI3412- 9-L (7-3/4")</b>
<b>CJ112-16 (16 teeth)</b>	1"	1/2"	-
<b>CJ112-25 (25 teeth)</b>	1"	1/2"	-
<b>CJ112-36 (36 teeth)*</b>	1"	1/2"	-

\* Not shown.



## CUP CHISELS

A bushing tool that will follow the contour of the stone and smooth the surface without digging in, the Cup Chisel leaves a unique finish.

	STOCK	SHANK
<b>CCC7812</b>	7/8"	1/2"
<b>CCC7858</b>	7/8"	5/8"

### TROW & HOLDEN TECH TIP

## BUSHING CHISELS

By using various Bushing Chisels with your pneumatic hammer, it is possible to rough out, finish carve and texture many types of stone. This valuable stoneworking technique not only saves time, but also produces a wider variety of surface finishes than possible with conventional hand tools.

Break in Bushing Chisels by using at medium power for an hour or two before using at full power.

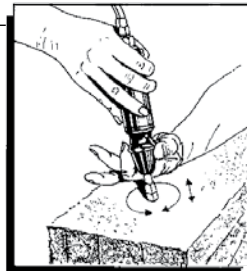

Do not hold onto the bushing chisel. Hold the pneumatic chisel perpendicular to the stone so the chisel moves freely, bouncing and spinning over the surface in a random pattern (called "dancing").

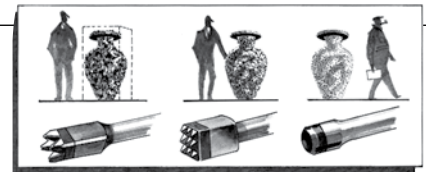

The 4-point chisel, above left, is ideal for roughing out your work and will leave a coarse texture. The 9-point chisel, center, removes less material but leaves a finer surface. The cup chisel, right, will not dig and is excellent for curved areas; use it to achieve a smoother texture prior to final finish.

## MARBLE FROSTING TOOLS

Use the Frosting Tool to leave a fine texture in marble or softer stone.

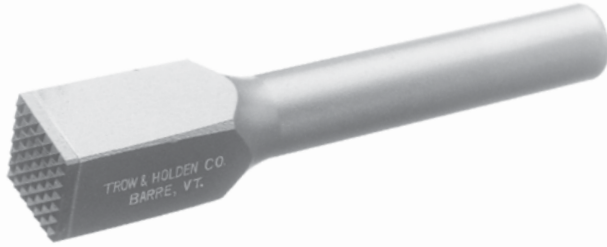

	STOCK	SHANK	ROWS OF TEETH	TEETH PER ROW
CM-25	1/2"	1/2"	5	5
CM-49	5/8"	1/2"	7	7
CM-64	3/4"	1/2"	8	8

## DOUBLE BLADE CHISELS

Use the Double Blade Chisel after the 4-Point or 9-Point for further smoothing.



	STOCK	SHANK	WIDTH OF BLADE
CH58121	5/8"	1/2"	1"
CH5812112	5/8"	1/2"	1-1/2"

## THREE BLADE BUSHING CHISELS

Use a Three Blade to create an axed or brushed finish.



	STOCK	SHANK
CJ1212-3CC	1/2"	1/2"
CJ5812-3CC	5/8"	1/2"

## CRISS-CROSS CHISELS

The Criss-Cross leaves a unique cross-hatched finish and nicely follows the 9-Point or Three Blade.



	STOCK	SHANK
CJ1212-4CC	1/2"	1/2"
CJ5812-4CC	5/8"	1/2"
CJ3412-4CC	3/4"	1/2"

## TROW & HOLDEN BUSHING SET | A Great Value!

### BUSHING SET

Anyone with a pneumatic carving hammer will simply love these bushing chisels.

This set makes a great addition to our Air-Powered Carving Set, shown on page 5.

#### SET INCLUDES:

- 5/8" sq. 4-Point with 1/2" shank
- 5/8" sq. 9-Point with 1/2" shank
- Cup Chisel with 1/2" shank
- Wooden Box (holds 4 chisels)

Bushing Set also available with 5/16" shank for Bantam hammers.

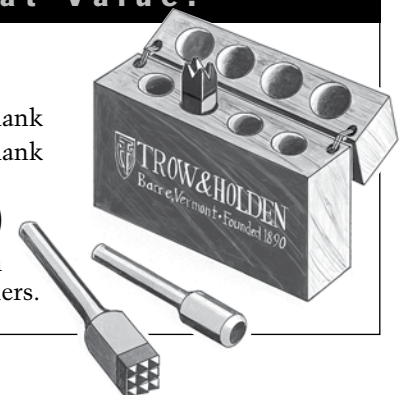

# MORTAR REMOVAL TOOLS



## CAPE CHISELS

The Cape Chisel is used for crisping lines, joining corners, or detailing. It is also used by masons for removing old mortar in preparation for repointing.

	STOCK	SHANK	WIDTH OF BLADE
CD121218	1/2"	1/2"	1/8"
CD1212316	1/2"	1/2"	3/16"
CD121214	1/2"	1/2"	1/4"
CD121238	1/2"	1/2"	3/8"

## RIPPERS

The Ripper is perfect for relief work and for getting into hard-to-reach places. It's also used by masons for mortar removal.

	STOCK	SHANK	NUMBER OF TEETH
CG1212-2	1/2"	1/2"	2
CG1212-3	1/2"	1/2"	3
CG5812-4	5/8"	1/2"	4
CG5858-4	5/8"	5/8"	4

## SWEPT CAPE CHISELS

The Swept Cape removes old mortar in preparation for repointing. Its curved shape helps clear debris from the joint. **Steel blade only.**

	WIDTH OF BLADE
AD1212316S	3/16"
AD121214S	1/4"
AD121238S	3/8"
AD121218S (with teeth)	1/8"

Ask us about custom modifications in blade shape, length or thickness to accommodate special mortar joint requirements.



## TROW & HOLDEN MASONRY RESTORATION SET | A Great Value!

### PNEUMATIC MORTAR REMOVAL SET

Our Pneumatic Mortar Removal Set is powerful enough to cut through the hardest mortars yet can be throttled down for fine detail work. Requires 6 cfm at 90 psi of air. The set includes:

- 1" Trow & Holden Type B Short Stroke Pneumatic Hammer
- 10' air hose assembly with Staubli push-button Quick Connect
- Striking cap and joint clean-out nozzle
- Four mortar removal chisels – 1/8" and 1/4" Carbide Cape Chisels, 4-tooth Carbide Ripper, and 1/4" Steel Swept Cape Chisel
- Chisel Retainer
- Canvas Tool Wrap for easy storage



# PNEUMATIC TOOL ACCESSORIES

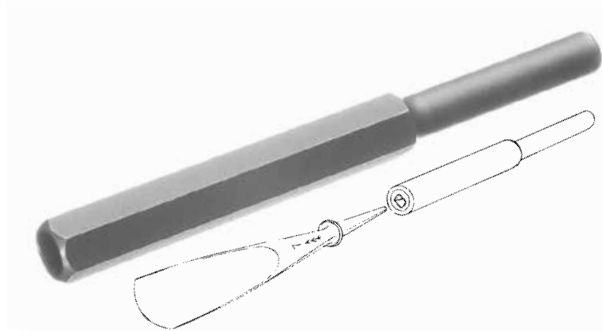

## WOOD CHISEL ADAPTOR

This adaptor will allow you to use tang-type wood chisels in a Trow & Holden Pneumatic Hammer for air-powered wood carving. A replaceable wooden dowel inside the Adaptor secures the chisel and ensures convenient chisel changes.

	STOCK	SHANK
S-WOOD	3/4"	1/2"



## STRIKING CAP FOR 1/2" SHANK TOOL

The Striking Cap provides a durable, detachable striking surface that slips securely onto any of our 1/2" shank pneumatic chisels. It's ideal for protecting the chisel's shank from irregular wear when occasional light-duty striking with a Hand Hammer is required.

	FITS SHANK SIZE
S-CAP	1/2" round

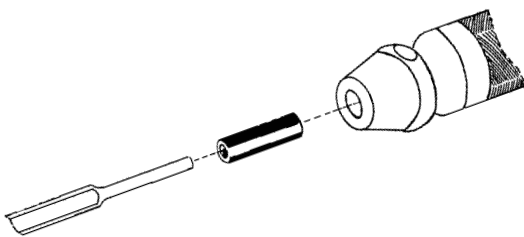

## SHANK ADAPTOR

The Shank Adaptor will enable you to use smaller 5/16" round shank chisels with Trow & Holden 1/2" shank pneumatic hammers.

	CONVERTS SHANK SIZE	TO SHANK SIZE
S-ADAPT	5/16"	1/2"



## ERGODYNE PROFLEX GLOVES

These half-finger gloves have segmented palm padding that reduces the effects of vibration and impact, without limiting dexterity or control. The gripping palm provides a secure hold on tools, while the built-in wrist support offers relief from repetitive motion discomfort.

	SIZE
ERG910/M	Medium
ERG910/L	Large
ERG910/XL	X-Large



Pistol Grip shown on 3/4" B Pneumatic Hammer (not included)

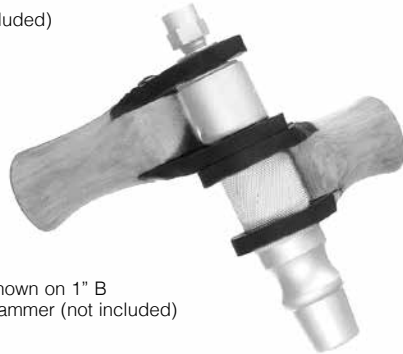

Dual Grips shown on 1" B Pneumatic Hammer (not included)

## AIR HAMMER PISTOL GRIPS & DUAL GRIPS

The Pistol Grip's snug-fitting rubber loops can be "shimmied" onto your air hammer, providing you with a contoured hardwood handle that will significantly reduce vibration while maintaining the speed and control you have come to expect from your Trow & Holden pneumatic hammers.

Featuring two handles, Dual Grips are perfect when working perpendicular to a surface for long periods, such as for mortar removal or for bushing large areas. We recommend using a Chisel Retainer whenever Dual Grips are used.

PISTOL GRIP	FITS PNEUMATIC HAMMER SIZE	DUAL GRIP
PG1	1/2" B, 1/2" D and 3/4" D	DG1
PG2	3/4" B	DG2
PG3	1" B and 1" D	DG3
PG4	1-1/4" D	DG4

## CHISEL RETAINERS

Secure your chisel inside the pneumatic hammer while keeping it loose and easy to control with this simple rubber looping system.

## SWIVEL RETAINERS

Secure your Bushing Chisel while keeping it free to "dance" on the stone with this flexible looping system.

CHISEL RETAINER	FITS	SHANK SIZE	SWIVEL RETAINER
CR1	BARRE BANTAM	5/16"	SR1
CR2	1/2" D Dallett Style	1/2"	SR2
CR3	1/2" B Short Stroke	1/2"	SR3
CR4	3/4" D Dallett-Style	1/2"	SR4
CR5	3/4" B Short Stroke	1/2"	SR5
CR6	1" D Dallett-Style	1/2"	SR6
CR7	1" B Short Stroke	1/2"	SR7
CR8	1-1/4" D Dallett-Style	5/8"	SR8

## CHISEL TILLERS

Reduce vibration and enhance control of your pneumatic chisels with the Chisel Tiller. The rubber loops are easy to install yet secure enough for roughing out. Three sizes are available to fit all of your air chisels.

	FITS STOCK SIZE
CW12	1/2"
CW58	5/8"
CW34	3/4"



Shown on 1/2" B Pneumatic Hammer (not included)



Shown on 1/2" B Pneumatic Hammer (not included)



Shown on CC1212F12NS Carving Chisel (not included)





## ADVANTAGE 200LS RESPIRATOR

This half-mask respirator offers protection from stone dust and is an especially great option when your project calls for the use of air hammers or power tools. The adjustable straps and pliable face cover ensure a snug and comfortable fit. Comes with a pair of replaceable filters.

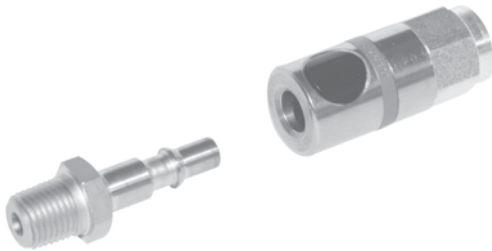

## STAUBLI QUICK CONNECTS

With Staubli Quick Connects, oiling your pneumatic hammer or switching to a different air tool are quick and easy. This particular set of quick connects also offers a unique two-stage push button release.

- **First press:** Stops air flow while leaving the air valve in position
- **Second press:** Fully disconnects the coupling

### STAUBLI QUICK CONNECTS

**SS330** Male Staubli Coupling Plug with 1/4" NPT Male Thread

**SS331** Female Staubli Coupling Socket with 1/4" NPT Female Thread



- **Full-length assemblies** are available in 10' increments and include all of the components listed above. The ABS stopcock is installed about 2' from one end to keep valve adjustments within reach.
- **Whips** are short Air Hose Assemblies that include all the components of a full-length assembly and attach to an existing hose.

## AIR HOSE ASSEMBLIES

Our Air Hose Assemblies offer a convenient way to connect your pneumatic hammer to your compressed air supply. Each Assembly is made of light, highly flexible, and very durable 3/8" air hose. They include male 1/4" NPT fittings on both ends and an in-line ABS valve for controlling air flow.

### FULL-LENGTH AIR HOSE ASSEMBLIES

**HOSEASSEMBLY10** 10' Hose Assembly

**HOSEASSEMBLY20** 20' Hose Assembly

**HOSEASSEMBLY30** 30' Hose Assembly

**HOSEASSEMBLY40** 40' Hose Assembly

### AIR HOSE ASSEMBLY WHIPS (not shown)

**HOSEWHIP2** 2' Hose Assembly Whip

**HOSEWHIP4** 4' Hose Assembly Whip

## PNEUMATIC HAMMER HOSE ASSEMBLY

Assembled air hose available with either brass or lightweight plastic stopcock. Staubli Quick Connect not included.

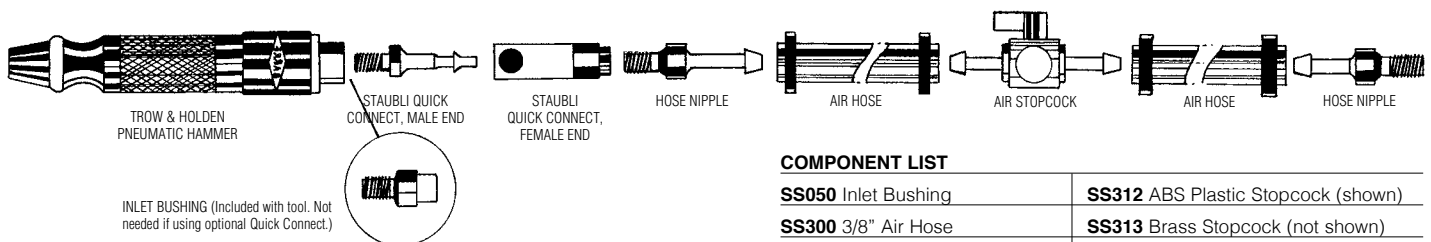

### COMPONENT LIST

<b>SS050</b> Inlet Bushing	<b>SS312</b> ABS Plastic Stopcock (shown)
<b>SS300</b> 3/8" Air Hose	<b>SS313</b> Brass Stopcock (not shown)
<b>SS301</b> Hose Nipple	<b>SS550</b> Airlube 10W/NR oil (not shown)

# CARBIDE HAND TOOLS

Trow & Holden's carbide-tipped hand tools are used by professional tradespeople, talented artisans, and skilled stoneworking enthusiasts alike. Carbide-tipped hand tools are extremely wear-resistant, and are ideal for the most demanding stoneworking applications. With proper usage, care, and maintenance, these tools deliver superior performance and durability. *Always wear eye protection when using any of our tools.*

Ask us about custom engraving, available on most hand tools.

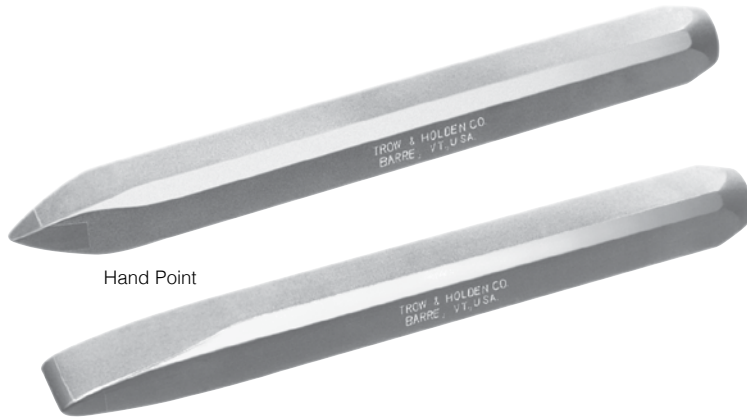

Hand Point

Hand Chisel

## HAND POINTS & HAND CHISELS

Use the Hand Point for roughing out and knocking off high spots, and use the Hand Chisel for carving and roughing out.

HAND POINT	STOCK	HAND CHISEL
CHP38	3/8"	CHC38
CHP12	1/2"	CHC12
CHP58	5/8"	CHC58
CHP34	3/4"	CHC34
CHP78	7/8"	CHC78
CHP1	1"	CHC1



## HAND TRACERS

Use a Tracer to split stone or to score a line before trimming.

	STOCK	WIDTH OF BLADE
CHT1112	1"	1-1/2"
CHT12	1"	2"
CHT1182	1-1/8"	2"
CHT118212	1-1/8"	2-1/2"
CHT1183	1-1/8"	3"
CHT1184	1-1/8"	4"



## HAND SETS

Use the Hand Set for trimming stone to size when the surface is relatively flat. The flat blade features two usable edges.

	STOCK	WIDTH OF BLADE
CHS1118	1"	1-1/8"
CHS1112	1"	1-1/2"
CHS12	1"	2"
CHS1182	1-1/8"	2"
CHS118214	1-1/8"	2-1/4"
CHS118212	1-1/8"	2-1/2"
CHS1183	1-1/8"	3"
CHS1184	1-1/8"	4"

Visit our website at [www.trowandholden.com](http://www.trowandholden.com) and check out the videos to see our tools in action!

## OFFSET HAND SETS

Like the Hand Set, the Offset Hand Set is used for rockfacing, squaring and trimming stone with a blade that's offset to prevent nicking corners and to deliver greater penetration into the face of the stone.

## MASON'S CHIPPERS

A variation of the Offset Hand Set, the blade of the Mason's Chipper is beveled back for better purchase on round or irregular surfaces.



Offset Hand Set

Mason's Chipper

OFFSET HAND SET	STOCK	WIDTH OF BLADE	MASON'S CHIPPER
CHO34114	3/4"	1-1/4"	CHOM34114
CHO1118	1"	1-1/8"	CHOM1118
CHO1112	1"	1-1/2"	CHOM1112
CHO12	1"	2"	CHOM12
CHO1182	1-1/8"	2"	CHOM1182
CHO118212	1-1/8"	2-1/2"	CHOM118212
CHO1183	1-1/8"	3"	CHOM1183
CHO1184	1-1/8"	4"	CHOM1184

## CARBIDE ROCKO HAND TOOLS

The Rocko is a specialized rock-facing or pitching tool. The blade has been designed to allow for a more vertical striking position while maintaining an ideal blade angle for pitching thin slabs of softer stone. The Rocko is best suited for rock-facing bluestone, sandstone, and limestone.



	STOCK	WIDTH OF BLADE
CRO58	5/8"	5/8"
CRO581	5/8"	1"
CRO34114	3/4"	1-1/4"
CRO78	7/8"	7/8"
CRO1	1"	1"
CRO1112	1"	1-1/2"
CRO12	1"	2"

## TROW & HOLDEN MASONRY SET | A Great Value!



Includes a  
Trow & Holden t-shirt!

## CARBIDE MASONRY SET

This set includes three of our most versatile stoneworking tools.

- The carbide-tipped **Stone Buster** gives you a splitting tool and a striking hammer in one tool. Choose a 2 lb. or 4 lb. hammer with vertical or horizontal blade. Comes with a 16" wood handle or substitute a fiberglass handle for an additional charge.
- The 2" carbide-tipped **Mason's Chipper** is perfect for trimming or squaring stone. The steeply angled blade and beveled carbide tip make it easier to see your work.
- The 1" stock carbide-tipped **Hand Point** will be the workhorse of your tool set. Use it to rough out and remove high spots, which will help extend the life of your wider-blade carbide tools.

## CARBIDE SWEPT GRIP HAND TOOLS

The contoured, hourglass-style handles on these carbide chisels have been well received across a wide range of stoneworking applications. Customers appreciate their "softer" feel and lightweight effectiveness.

Swept Grip Hand Set

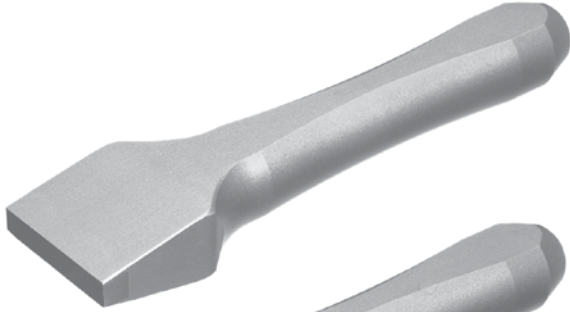

Swept Grip Hand Tracer



Swept Grip Mason's Chipper

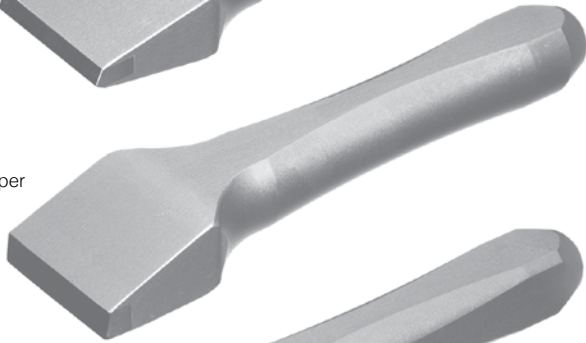

Swept Grip Bull Point

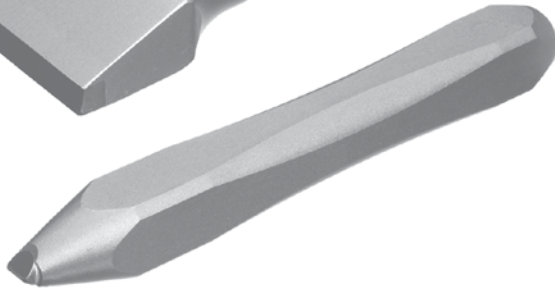

SWEPT GRIP HAND SETS	STOCK	WIDTH OF BLADE
CHS1112SG	1"	1-1/2"
CHS12SG	1"	2"

SWEPT GRIP HAND TRACERS	STOCK	WIDTH OF BLADE
CHT1112SG	1"	1-1/2"
CHT12SG	1"	2"

SWEPT GRIP MASON'S CHIPPERS	STOCK	WIDTH OF BLADE
CHOM1118SG	1"	1-1/8"
CHOM1112SG	1"	1-1/2"
CHOM12SG	1"	2"

The Carbide Bull Point features a beveled tip. This provides better purchase on the surface of the stone, making it ideal for heavy material removal and efficiently working down high spots over a broad surface area.

SWEPT GRIP BULL POINT	STOCK	WIDTH OF BLADE
CHP1BP	1"	3/8"

## TROW & HOLDEN SWEPT GRIP TOOL SET | A Great Value!

### SWEPT GRIP SET

This versatile set of hand tools will get you off to a great start on almost any stoneworking project. The 1" shanks are slightly scaled-down from the Comfort Grip tools, and they feature the same high quality carbide blades to maximize performance and wear resistance. Enjoy the comfortable swept shank design while you split, trim and rough out any type of stone.

The set includes:

- Swept Grip Hand Tracer with 2" blade
- Swept Grip Mason's Chipper with 1-1/2" blade
- Swept Grip Bull Point
- 2 lb. Hand Hammer with oval eye and 12" wood handle
- Trow & Holden Tool Bag in heavy duty canvas
- Safety glasses



# CARBIDE COMFORT GRIP HAND TOOLS

Our Comfort Grip carbide hand tools feature contoured handles which provide a secure grip for more powerful blows.



Comfort Grip Round Point



Comfort Grip Mason's Chipper



Comfort Grip Heavy Point

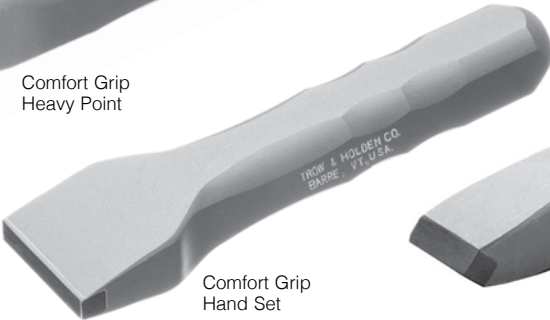

Comfort Grip Hand Set



Comfort Grip Hand Chisel



Comfort Grip Hand Tracer

		STOCK	WIDTH OF BLADE
CHP138CG	COMFORT GRIP ROUND POINT	1-3/8"	-
CHOM1182CG	COMFORT GRIP MASON'S CHIPPER	1-1/8"	2"

Heavy duty carbide blades on the Comfort Grip Chisel and Tracer are uniquely designed for the most aggressive applications in the hardest stone.

The following four Comfort Grip tools are available individually as well as in a set with special pricing. See Comfort Grip Collection, below.

		STOCK	WIDTH OF BLADE
CHP114CG	COMFORT GRIP HEAVY POINT	1-1/4"	-
CHS1182CG	COMFORT GRIP HAND SET	1-1/8"	2"
CHC114CG	COMFORT GRIP HAND CHISEL	1-1/4"	1-1/4"
CHT1182CG	COMFORT GRIP HAND TRACER	1-1/8"	2"

## TROW & HOLDEN COMFORT GRIP TOOL SET | A Great Value!



### COMFORT GRIP COLLECTION

Working in hard stone is hard work! We developed these chisels for maximum productivity when splitting, shaping and roughing out granite or other very hard material. This set includes our signature Oval Eye Hand Hammer with a 4-degree bevel to promote solid contact with the chisel.

All of our tools are manufactured from the highest quality American-made steel and carbide. Included are:

- Comfort Grip Heavy Point
- Comfort Grip Hand Chisel with 1-1/4" heavy duty blade
- Comfort Grip Hand Set with 2" blade
- Comfort Grip Hand Tracer with 2" heavy duty blade
- 3 lb. Hand Hammer with oval eye and 12" wood handle
- Trow & Holden Tool Bag in heavy duty canvas

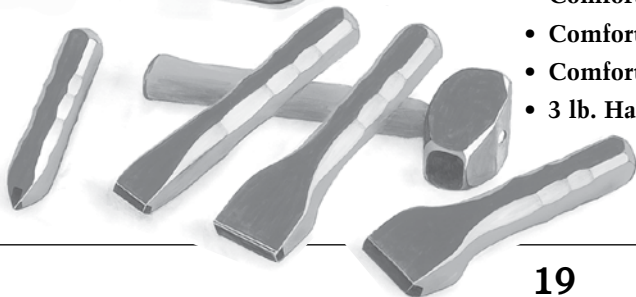



## DETAIL CARVING CHISELS

Our smallest carbide hand chisels feature a tapered shank, making it easier to get into tight spaces for fine detail carving. Chisels are 7" long. Available with straight or rondel blade.

	STOCK	WIDTH OF BLADE
<b>CHC18</b>	5/16"	1/8"
<b>CHC316</b>	5/16"	3/16"
<b>CHC14</b>	5/16"	1/4"



## HAND CARVING & LETTERING CHISELS

Hand Carving and Lettering Chisels are 8-1/2" long for greater control when working close-up. Blades feature fine tapers with durable carbide tips. Stock feels comfortable during extended use. Blade widths range from 1/8" through 1/2".

	HEXAGONAL STOCK	WIDTH OF BLADE
<b>CHC38-18X</b>	3/8"	1/8"
<b>CHC38-14X</b>	3/8"	1/4"
<b>CHC38-38X</b>	3/8"	3/8"
<b>CHC12-14X</b>	1/2"	1/4"
<b>CHC12-38X</b>	1/2"	3/8"
<b>CHC12-12X</b>	1/2"	1/2"



## CARBIDE MALLET HEAD CHISELS

With stock sizes of 1/2" or 5/8", these carbide-tipped chisels are perfect for sculpting granite, limestone, or other hard stone. Also available in steel (see page 22).

All styles available with either flat or rondel blades.  
NOTE: Toothed blades not recommended on 1/2" stock tools.

1/2" STOCK	WIDTH OF BLADE	5/8" STOCK
<b>CMC34</b>	3/4"	-
<b>CMC1</b>	1"	<b>CF58121H</b>
<b>CMC114</b>	1-1/4"	<b>CF5812114H</b>
<b>CMC112</b>	1-1/2"	<b>CF5812112H</b>
<b>CMC2</b>	2"	<b>CF58122H</b>
<b>CMC212</b>	2-1/2"	-
<b>CMC3</b>	3"	-

See page 6 for tooth styles.

To order tooth chisels, determine what size blade you would like and after it place the letter of the tooth style you want.

**TROW & HOLDEN CARBIDE-TIPPED HAND CARVING SET | A Great Value!**

## HARD STONE HAND CARVING SET

CHOICE OF HAMMERS  
1 1/2" SQUARE OR 1 1/2" ROUND

This set features **carbide-tipped chisels**, which will keep their edge and last many times longer than steel tools. Use them for hand carving in granite, hard marble, or anytime you're looking for improved performance in your stone carving tools. Set includes:

- 1/2" Hand Point
- 3/8" Hand Chisel
- 1/2" Hand Chisel with teeth
- 3/4" Mallet Head Chisel
- 1" Mallet Head Chisel
- **Your choice of:** 1-1/2 lb. Round Hammer with 7" handle or 1-1/2 lb. Soft Stone (Square) Hammer with 12" handle
- **Canvas Tool Wrap** for easy storage

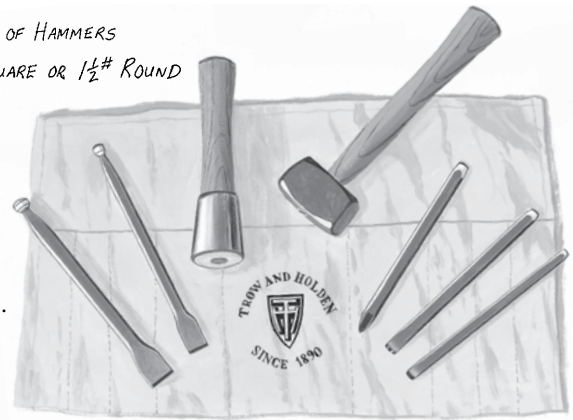

**TROW & HOLDEN HAND CARVING & LETTERING SET | A Great Value!**

CHOICE OF HAMMERS

## HAND CARVING & LETTERING SET

Our redesigned **carbide-tipped** lettering chisels feature hex shanks and a finer taper for maximum control. This set offers a variety of blade widths useful for small to larger lettering. Makes a great gift! Includes:

- **Six Lettering Chisels** in sizes from 1/8" through 1/2"
- **Your choice of:** 1 lb. Round Hammer with 7" handle, 1 lb. Brass Hammer with 7" handle, or 1-1/2 lb. Soft Stone (Square) Hammer with 12" handle
- **Canvas Tool Wrap** for easy storage



**TROW & HOLDEN HARDENED STEEL CHISEL SET | A Great Value!**

CHOICE OF HAMMERS  
1 1/2" SQUARE OR 1 1/2" ROUND

## SOFT STONE HAND CARVING SET

If your medium is softer stone, this set offers a variety of **hardened steel chisels** in sizes and styles to meet your needs. Also check out our other steel hand tools on the following two pages. Set includes:

- **Two Flat Chisels** – 3/8" and 3/4" blade, both with 3/8" stock
- **Two Tooth Chisels** – 3/8" stock with 3/4" blade and pointed teeth, and 1/2" stock with 5/8" blade and square teeth
- **1/2" stock Rondel Chisel** with 3/4" blade, and **1/2" Hand Point**
- **Your choice of:** 1-1/2 lb. Soft Stone (Square) Hammer (12" handle) or 1-1/2 lb. Round Hammer (7" handle)
- **Canvas Tool Wrap** for easy storage

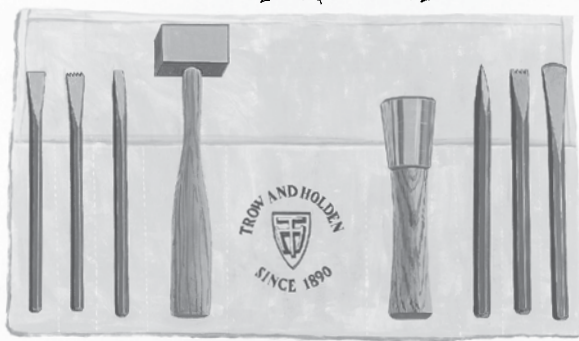

# STEEL HAND TOOLS

Trow & Holden's steel hand tools are made from the same high-quality tool steel as the rest of our stoneworking tools, and offer a significant advantage over inexpensive alternatives when working in softer, less demanding types of stone.



## SOFT STONE Mallet Head Chisels

The straight blade chisels are used for smoothing stone after the final shaping is completed. The tooth chisel is used for roughing out and for more aggressive material removal.

1/2" STOCK	WIDTH OF BLADE	5/8" STOCK
AMC34	3/4"	-
AMC1	1"	AF58121H
AMC114	1-1/4"	AF5812114H
AMC112	1-1/2"	AF5812112H
AMC2	2"	AF58122H
AMC212	2-1/2"	-
AMC3	3"	-

All styles available with flat, rondel or tooth blades. See page 6 for tooth styles. To order tooth chisels, determine what size blade you would like and after it place the letter of the tooth style you want.



## FLARED CHISELS

The Flared Chisels are used for sculpting. The narrow neck allows access to hard-to-reach places.

	STOCK	WIDTH OF BLADE
AHC38-12	3/8"	1/2"
AHC38-58	3/8"	5/8"
AHC38-34	3/8"	3/4"
AHC12-58	1/2"	5/8"
AHC12-34	1/2"	3/4"
AHC12-1	1/2"	1"

Available with teeth or rondel — see page 6.

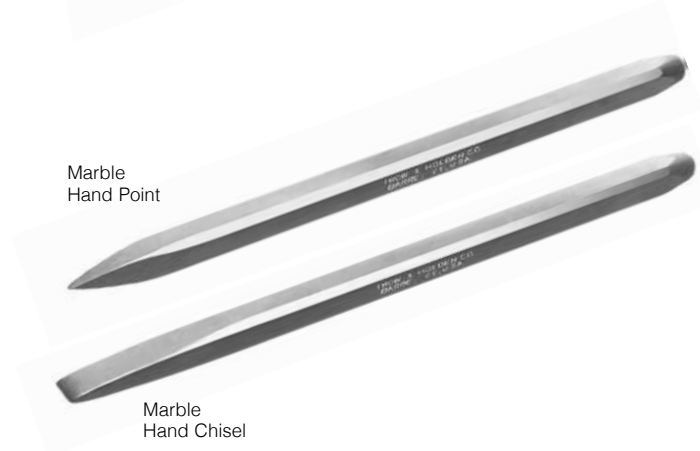

Marble Hand Point

Marble Hand Chisel

## MARBLE HAND POINTS & HAND CHISELS

The Marble Hand Points and Chisels are used for roughing out and general shaping.

POINT	STOCK	CHISEL
AHP38	3/8"	AHC38
AHP12	1/2"	AHC12
AHP58	5/8"	AHC58
AHP34	3/4"	AHC34

Marble Hand Chisels available with teeth or rondel — see page 6.



## GRANITE HAND POINTS & HAND CHISELS

Use Granite Hand Points and Chisels for work in very hard stone such as black granite or basalt, where carbide tips are vulnerable to damage. These are harder than the corresponding Marble Chisels and can be brought to a sharper edge than carbide chisels.

Granite Chisel



Granite Point

POINT	STOCK	CHISEL
AHPG38	3/8"	AHCG38
AHPG12	1/2"	AHCG12
AHPG58	5/8"	AHCG58
AHPG34	3/4"	AHCG34
AHPG78	7/8"	AHCG78
AHPG1	1"	AHCG1

## HAND CHIPPERS & HAND TRACERS

Use the Chipper to trim polished blocks or bases made of softer material such as limestone or marble. The Tracer is used for scoring or for splitting the stone.

Hand Chipper

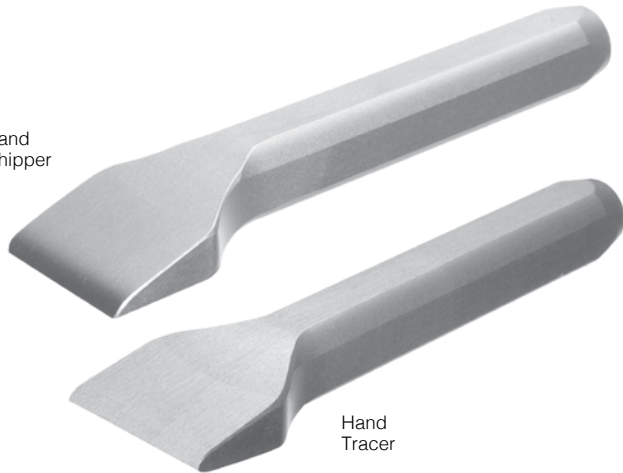

Hand Tracer

CHIPPER	STOCK	WIDTH OF BLADE	TRACER
AHCH121	1/2"	1"	-
AHCH1112	1"	1-1/2"	AHT1112
AHCH12	1"	2"	AHT12
-	1-1/8"	2"	AHT1182
AHCH118212	1-1/8"	2-1/2"	AHT118212
AHCH1183	1-1/8"	3"	AHT1183
AHCH1184	1-1/8"	4"	AHT1184

## HAND SETS & OFFSET HAND SETS

The steel Hand Sets and Offset Hand Sets are used for trimming or squaring up softer stone.

Hand Set

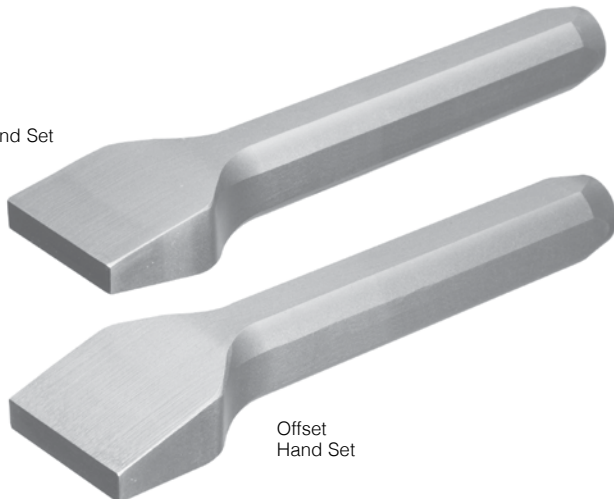

Offset Hand Set

HAND SET	STOCK	WIDTH OF BLADE	OFFSET
AHS1234	1/2"	3/4"	-
AHS121	1/2"	1"	-
AHS1112	1"	1-1/2"	AHO1112
AHS12	1"	2"	AHO12
AHS1182	1-1/8"	2"	AHO1182
AHS118212	1-1/8"	2-1/2"	AHO118212
AHS1183	1-1/8"	3"	AHO1183

# TOOLS FOR THIN STONE

## SLATE SPLITTERS

Use to cleave slate into thinner layers along its natural seams.



	BLADE	OVERALL LENGTH
<b>NEW</b> SLSP1	1" wide	9"
SLSP2	2" wide	9"
<b>NEW</b> SLSP212	2-1/2" wide	9"
<b>NEW</b> SLSP3	3" wide	9"

## SLATE WEDGE

This heavier-duty slate splitting tool has a thicker and longer blade, making it perfect for roughing out large pieces of slate.



	BLADE	OVERALL LENGTH
SLW	2" wide	10"

## T-SCRIBE

Use for etching lines in slate before breaking or splitting. T-shaped handle offers a secure grip and the carbide tip lasts and lasts.

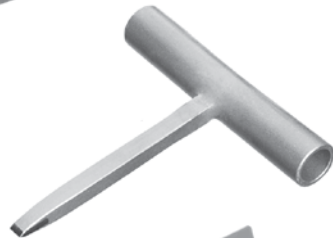

	BLADE	LENGTH
CT-SCRIBE	1/8"	4-1/2"

## THIN STONE VENEER HARDIE

Hand-trim thin stone veneer with speed and control. We recommend pairing with our Thin Stone Veneer Hammer (page 31). The Hardie provides a solid but portable base for trimming fragile thin stone — even prefab corners!

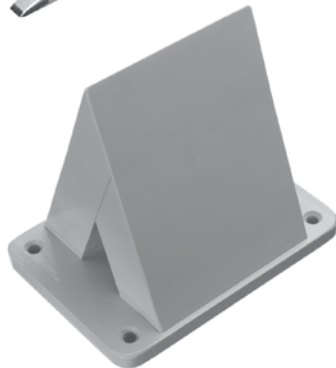

	WEIGHT
HTSV-HARDIE	12 lbs.

### TROW & HOLDEN THIN STONE VENEER SET | A Great Value!

## THIN STONE VENEER SET

Achieve a more refined hand-cut finish when trimming thin stone veneer with our Thin Stone Veneer tools — all while reducing the reliance on dusty and dangerous saws and grinders. Set includes:

- **12 lb. Thin Stone Veneer Hardie** with 4" hardened steel stonecutting blade, coated in Safety Orange for increased job site visibility
- **2 lb. Thin Stone Veneer Trimming Hammer** with 1-1/4" carbide trimming blade, beveled striking face and 12" handle
- **1-1/4" Carbide Mason's Chipper** with 3/4" stock for cleaning up edges and making final adjustments

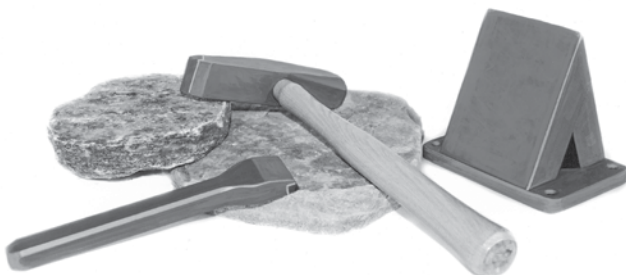

# HAND TOOL ACCESSORIES



Shown on CHT1182  
Hand Tracer (not included)

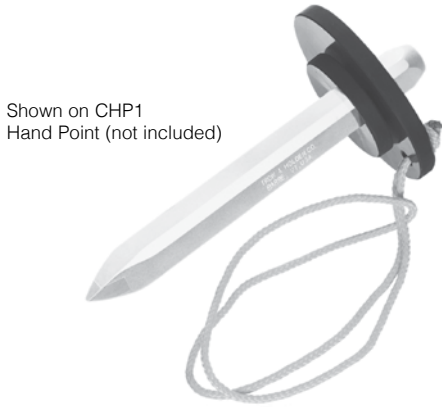

Shown on CHP1  
Hand Point (not included)

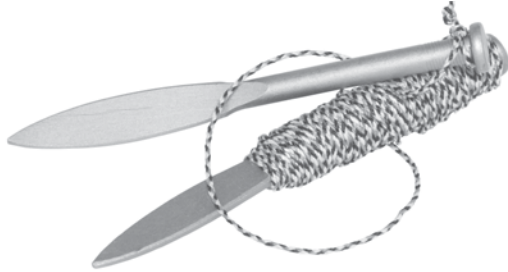

## CHISEL WHIZARDS

Get your hand out of harm's way and eliminate shock and vibration with the simple yet effective Chisel Whizard. Sizes are available to fit all Trow & Holden hand tools.

## HAND SHIELDS

Protect your hand with our polyurethane Hand Shield. The smaller disc prevents the Shield from sliding down the stock and reduces pinching. Removable lanyard prevents the chisel from hitting the ground if accidentally dropped.

CHISEL WHIZARD	FITS STOCK SIZE	HAND SHIELD
CW12	1/2"	-
CW58	5/8"	-
CW34	3/4"	-
CW78	7/8"	-
CW1	1"	HS1
CW118	1-1/8"	HS118

## WALLING PINS

Used in pairs with nylon mason's line, these hand-forged pins can be set in a wall or anchored in the soil to maintain a taut guideline during dry stack stone construction.

WALLPIN SET	Set of 2 with nylon line included
-------------	-----------------------------------

### TROW & HOLDEN TECH TIP

## HAND TOOLS

Selecting the right size and type hand tool will save you time and money and give better results. The right size tool will feel comfortable in your hand and allow complete contact of blade to stone; using the right type of tool will help prevent breakage and make your work more efficient. **Remember**, whatever chisel you use, **make sure your first hit is a light hit**. This will help "set" the tool and put the blade fully in contact with the stone. Three commonly used hand tools are illustrated here:

- A **Tracer** is used to split stone. Move your tracer back and forth along the split line, striking it until the stone splits. Hold it perpendicular to the stone.
- Trim and square your stone by tipping your **Hand Set** slightly back onto its edge and striking along your line. When your blade becomes dull, turn and use the other edge.
- Use a **Hand Point** to remove high spots by striking at different angles around the area to be removed. For granite or other hard stone, hold the hand point vertically for the first strike. This tool is also perfect for roughing out. Remember to trim the striking head and sharpen the blade regularly for safe and efficient use.

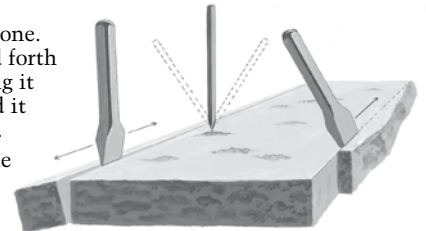

# HAMMERS

Trow & Holden has been making stoneworking hammers for more than 130 years. Being located in the heart of granite country has given us access to the perfect testing ground for our products, so the design of the hammers has evolved until they are perfectly suited for their purpose. Some of our hammers have very specific functions; others are more versatile.

To ensure your safety and to maximize the life of your hammer, please take care to read hammer descriptions carefully. Some of our hammers are intended to be used for striking hand tools and hammers, some can be set in place and struck by other hammers, and others are for striking stone only. Please contact us if you have questions regarding the appropriate use or care of our stoneworking hammers.

Hickory handles are included with all hammers, except where specified, and replacement handles can be found on page 33. *Always wear eye protection when using stoneworking tools.*



## HAND HAMMERS

Used for striking hand tools or wedges and shims, the Hand Hammer is hardened for a more powerful blow and better wear. Available with traditional round eye and beveled head, or with oval eye and larger striking surface. Fiberglass handle available at additional cost.

	WEIGHT	HANDLE LENGTH
<b>HCH1</b>	1 lb.	13" wood or fiberglass
<b>HCH114</b>	1-1/4 lbs.	13" wood or fiberglass
<b>HCH112</b>	1-1/2 lbs.	13" wood or fiberglass
<b>HCH134</b>	1-3/4 lbs.	13" wood or fiberglass
<b>HCH2</b>	2 lbs.	13" wood or fiberglass
<b>HCH214</b>	2-1/4 lbs.	13" wood or fiberglass
<b>HCH212</b>	2-1/2 lbs.	13" wood or fiberglass
<b>HCH234</b>	2-3/4 lbs.	13" wood or fiberglass
<b>HCH3</b>	3 lbs.	13" wood or fiberglass
<b>HCH314</b>	3-1/4 lbs.	13" wood or fiberglass
<b>HCH312</b>	3-1/2 lbs.	13" wood or fiberglass
<b>HCH334</b>	3-3/4 lbs.	13" wood or fiberglass
<b>HCH4</b>	4 lbs.	13" wood or fiberglass
<b>HCH20E</b> (with oval eye)	2 lbs.	12" wood or 13" fiberglass
<b>HCH212OE</b> (with oval eye)	2-1/2 lbs.	12" wood or 13" fiberglass
<b>HCH30E</b> (with oval eye)	3 lbs.	12" wood or 13" fiberglass
<b>HCH312OE</b> (with oval eye)	3-1/2 lbs.	12" wood or 13" fiberglass
<b>HCH40E</b> (with oval eye)	4 lbs.	12" wood or 13" fiberglass

## BELL HAMMERS

The Bell Hammer provides an alternative to the Hand Hammer. Like our other round hammers, it does not need to be squared up to the chisel, but will make full contact wherever it hits. Fiberglass handle available at additional cost.

	WEIGHT	HANDLE LENGTH
<b>HBB2</b>	2 lbs.	14" wood or 14" fiberglass
<b>HBB212</b>	2-1/2 lbs.	14" wood or 14" fiberglass
<b>HBB3</b>	3 lbs.	14" wood or 14" fiberglass
<b>HBB312</b>	3-1/2 lbs.	14" wood or 14" fiberglass
<b>HBB4</b>	4 lbs.	14" wood or 14" fiberglass





## BULL SETS

Using the Bull Set is a two-person operation for roughing out or shaping large blocks of stone. One person holds the hammer, angling the blade slightly toward the outside of the stone. The other person then hits it with the striking hammer. With use, the breaking edge of the hammer will wear down; the hammer can then be turned around on its handle and the other side used. **This hammer is not meant to be swung.**

Also available in carbide. Carbide lasts longer and requires less maintenance than steel; however, it is more vulnerable to breaking if placed on an uneven surface. Be sure to use the Carbide Bull Set only on sawed or polished blocks of stone.

	WEIGHT	HANDLE LENGTH*
<b>HBS8</b>	8 lbs.	30" wood
<b>HBS10</b>	10 lbs.	30" wood
<b>HBS12</b>	12 lbs.	30" wood

### CARBIDE TIP

<b>HBS8CT</b>	8 lbs.	30" wood
<b>HBS10CT</b>	10 lbs.	30" wood
<b>HBS12CT</b>	12 lbs.	30" wood

\* To promote even wear, fiberglass handle not recommended for this hammer. See our Trow & Holden Guide to Hammers.

## SLAB SPLITTERS

Use the same way as a Bull Set, but use it to split down the middle of a stone rather than along the edge. **This hammer is not meant to be swung.** Also available in carbide. Fiberglass handle available at additional cost.

	WEIGHT	HANDLE LENGTH
<b>HSS8</b>	8 lbs.	30" wood or 32" fiberglass
<b>HSS10</b>	10 lbs.	30" wood or 32" fiberglass
<b>HSS12</b>	12 lbs.	30" wood or 32" fiberglass

### CARBIDE TIP

<b>HSS10CT</b>	10 lbs.	30" wood or 32" fiberglass
<b>HSS12CT</b>	12 lbs.	30" wood or 32" fiberglass

## QUARRY BUSTERS

Like our smaller Stone Buster, the Quarry Buster can be swung to deliver a powerful splitting blow. The blade can also be placed on the stone and the Quarry Buster struck by another hammer, or the striking head can be used to strike another hammer or stone. Fiberglass handle available at additional cost.

	WEIGHT	HANDLE LENGTH
<b>HQB10</b>	10 lbs.	30" wood or 32" fiberglass
<b>HQB12</b>	12 lbs.	30" wood or 32" fiberglass
<b>HQB14</b>	14 lbs.	32" wood or 32" fiberglass

## STONE MASON'S or MASH HAMMERS

This traditional hammer features a splitting blade on one end and a flat trimming head on the other. Use it to strike stone only, never another tool.

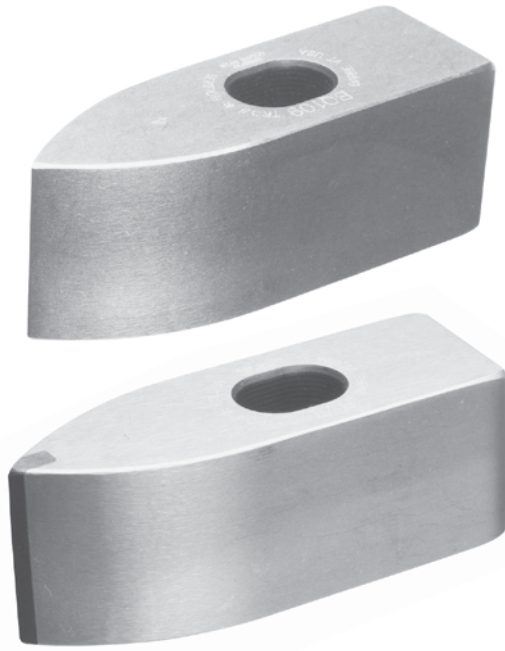

	WEIGHT	HANDLE LENGTH*
<b>HMH2</b>	2 lbs.	16" wood
<b>HMH3</b>	3 lbs.	16" wood
<b>HMH4</b>	4 lbs.	16" wood
<b>HMH6</b>	6 lbs.	30" wood
<b>HMH8</b>	8 lbs.	30" wood
<b>HMH10</b>	10 lbs.	30" wood
<b>HMH12</b>	12 lbs.	30" wood
<b>HMH14</b>	14 lbs.	32" wood
<b>HMH16</b>	16 lbs.	32" wood
<b>HMH18</b>	18 lbs.	32" wood

### CARBIDE TIP

<b>HMH2CT</b>	2 lbs.	16" wood
<b>HMH3CT</b>	3 lbs.	16" wood
<b>HMH4CT</b>	4 lbs.	16" wood

\* To promote even wear, fiberglass handle not recommended for this hammer. See our Trow & Holden Guide to Hammers.

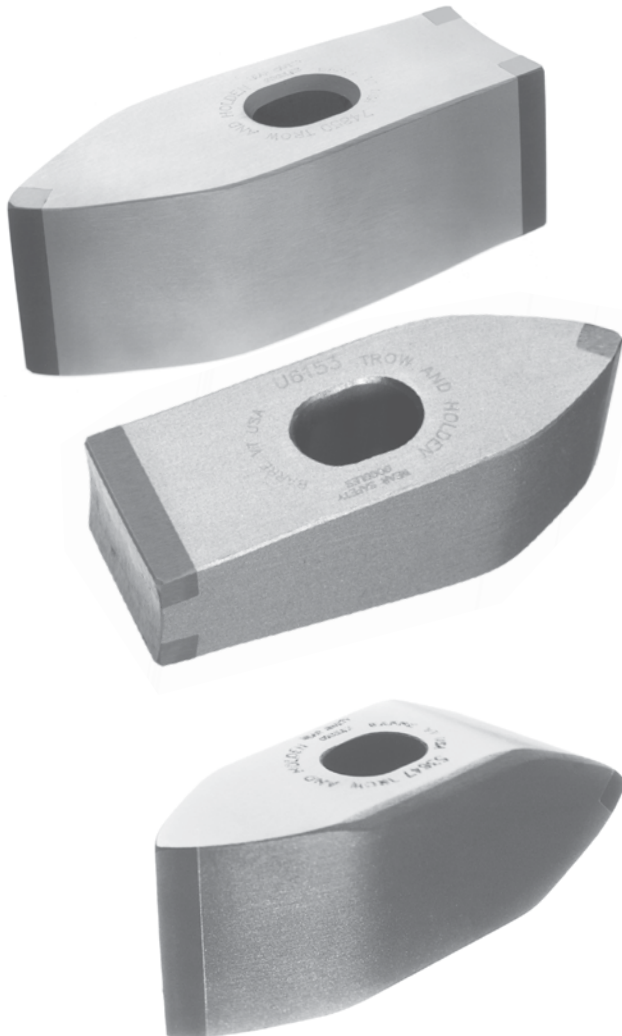

## ULTIMATE MASH HAMMERS

Providing the best wear resistance of any stonecutting hammer on the market, our **carbide-tipped** Ultimate Mash Hammer features heavy-duty carbide tips on the blade and both edges of the back cutting head. Now you can split and trim the hardest stones without the frequent regrinding and re-tempering necessary with steel blade hammers. The back head is ground concave, making it easy to dress with the same 6" or 8" silicon carbide grinding wheel used to grind the blade. 3 lb. hammer available with horizontal trimming edges.

	WEIGHT	HANDLE LENGTH*
<b>HMH3CTBE</b>	3 lbs.	16" wood
<b>HMH3CTBE/H</b>	3 lbs.	16" wood
<b>HMH4CTBE</b>	4 lbs.	16" wood

\* To promote even wear, fiberglass handle not recommended for this hammer. See our Trow & Holden Guide to Hammers.

## CARBIDE DOUBLE BLADE MASON'S HAMMER

The Double Blade Mason's Hammer features the same heavy duty **carbide-tipped** blade as our Stone Buster, but gives you both a vertical and horizontal blade in one hammer. Fiberglass handle available at additional cost.

	WEIGHT	HANDLE LENGTH
<b>HDB3CT</b>	3 lbs.	16" wood or fiberglass



## STONE BUSTERS

One of our most popular stoneworking hammers, the Stone Buster can be used in three ways to maximize stone cutting power and efficiency. It can be swung as a striking hammer, utilizing its beveled striking head to strike hand tools or other dual-purpose hammers. Its heavy-duty carbide-tipped blade can also be swung directly into the stone for quick trimming or splitting. Or, when maximum force and accuracy is desired, its carbide blade can be held in place on the stone while being struck by another hammer of comparable weight.

	WEIGHT	HANDLE LENGTH
<b>HSB2CT/V</b>	2 lbs./Vertical Blade	16" wood or fiberglass
<b>HSB2CT/H</b>	2 lbs./Horizontal Blade	16" wood or fiberglass
<b>HSB4CT/V</b>	4 lbs./Vertical Blade	16" wood or fiberglass
<b>HSB4CT/H</b>	4 lbs./Horizontal Blade	16" wood or fiberglass

## HAMMER SETS

Our carbide-tipped Hammer Set allows you to deliver a powerful and accurate blow to make edge work and pitching go even faster. Position the blade at the desired angle on the stone, then strike the beveled head with another hammer of comparable weight. Like the Stone Buster, the Hammer Set can also be used for striking hand tools or other dual-purpose hammers of comparable size.

	WEIGHT	HANDLE LENGTH*
<b>HHS4CT/V</b>	4 lbs./Vertical Blade	16" wood
<b>HHS4CT/H</b>	4 lbs./Horizontal Blade	16" wood

\* To promote even wear, fiberglass handle not recommended for this hammer. See our Trow & Holden Guide to Hammers.

## CARBIDE HAMMER POINTS

Our exclusive Hammer Point features a rugged carbide-tip point and wear-resistant striking head. It removes high spots with ease, and makes quick work of aggressive material removal. Like our other dual-purpose hammers, it can be held in position and struck by another hammer of comparable weight or used as a striking hammer. Comes standard with fiberglass special grip handle.

	WEIGHT	HANDLE LENGTH
<b>HHP2CT</b>	2 lbs.	13" fiberglass
<b>HHP4CT</b>	4 lbs.	13" fiberglass

## TROW & HOLDEN DRY STONE WALLING SET | A Great Value!

### DRY STONE WALLING SET

Split 'em, shape 'em and stack 'em with our Dry Stone Walling Set — no mortar required! Enhance your property for decades to come with a dry-stack stone wall built with quality Trow & Holden tools. Set includes:

- Carbide-tipped **Hammer Point**, **Hand Tracer** and **Rock Pick**
- Set of four **Walling Pins** and twine for a true line
- A **guide**, *Building and Repairing Dry Stone Fences*
- **Safety glasses** and **Trow & Holden Canvas Tool Bag**





## THE STINGERS

Our exclusive design has carbide on both ends making it suitable for shaping on any type of stone. It features a point on one end and a chisel blade on the other for quick and easy pointing, chiseling and splitting. It is available in either a 2 or 4 lb. weight, with vertical or horizontal blade. Fiberglass handle available at additional cost.

	WEIGHT	HANDLE LENGTH
<b>STINGER 2/V</b>	2 lbs./Vertical Blade	16" wood or fiberglass
<b>STINGER 2/H</b>	2 lbs./Horizontal Blade	16" wood or fiberglass
<b>STINGER 4/V</b>	4 lbs./Vertical Blade	16" wood or fiberglass
<b>STINGER 4/H</b>	4 lbs./Horizontal Blade	16" wood or fiberglass

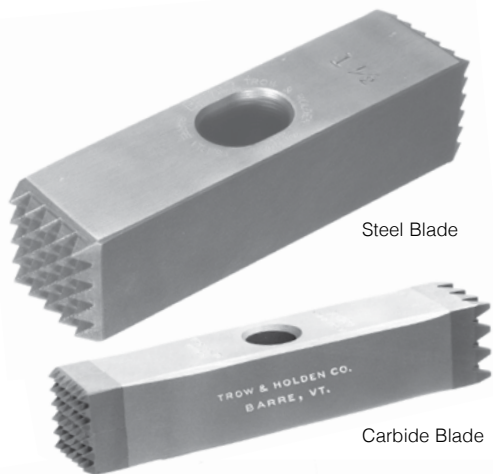

Steel Blade

Carbide Blade

## SOLID TOOTH BUSH HAMMERS

For shaping, texturing, or smoothing soft stone, these hammers will leave a stippled finish on stone surfaces. To avoid premature wear on steel-toothed hammers or breakage on carbide-toothed hammers, do not use for surfacing hard stones such as granite, basalt or quartzites. Fiberglass handle available at additional cost.

	STOCK	LENGTH	WEIGHT	HANDLE LENGTH
<b>HBH1SQ</b>	1"	5"	1-1/2 lbs.	12" wood or fiberglass
<b>HBH112SQ</b>	1-1/2"	6"	3-1/2 lbs.	16" wood or fiberglass
<b>HBH134SQ</b>	1-3/4"	6-1/2"	5-1/2 lbs.	16" wood or fiberglass
<b>HBH2SQ</b>	2"	7"	7-1/2 lbs.	16" wood or fiberglass

CARBIDE TIP	STOCK	LENGTH	WEIGHT	HANDLE LENGTH
<b>HBH1SQCT</b>	1"	5"	1-1/2 lbs.	12" wood

Steel hammers have 25 teeth one end, 36 teeth other end.  
Carbide hammer has 16 teeth one end, 25 teeth other end.



Carbide Bushing Head

Steel Head

Carbide Trimming Head

## CARBIDE MILL PICK

Traditionally used for dressing mill stones, the Mill Pick is also handy for chiseling lines in stone or for trimming edges. Carbide tip means longer wear. Length of hammer head is 7-1/2". Fiberglass handle available at additional cost.

	WEIGHT	HANDLE LENGTH
<b>HMP2CT</b>	2 lbs.	16" wood or fiberglass

## ROCK PICKS

We are proud to offer Vaughn® hammers that we have modified with carbide-tipped blades. Used for light-duty trimming and texturing stone, our 24 oz Rock Picks come in three styles. All styles have a carbide chisel blade. Choose from a steel striking head, a flat carbide trimming head or a carbide bushing head. Avoid using on corners and make sure carbide lands flat on stone.

	HANDLE LENGTH
<b>HRP24B</b> Carbide Blade Only	12" wood
<b>HRP24BH</b> Carbide Blade & 16-Pt Bushing Head	12" wood
<b>HRP24BTH</b> Carbide Blade & Trimming Head	12" wood



## TRIMMING HAMMERS

Patterned after traditional designs, these Trimming Hammers are well-balanced and most feature slightly concave faces. As with the Mash Hammers, Trimming Hammers are intended for striking stone only. They should never be used to hit another tool, nor be hit by another hammer.

	WEIGHT	HANDLE LENGTH*
<b>HTH312</b> with two Concave Faces	3-1/2 lbs.	16" wood
<b>HTH412</b> with two Concave Faces	4-1/2 lbs.	16" wood
<b>HTH2B</b> with Blade & Concave Face	2 lbs.	16" wood
<b>HTH312B</b> with Blade & Concave Face	3-1/2 lbs.	16" wood
<b>HTH4</b>	4 lbs.	16" wood
<b>HTH5</b>	5 lbs.	16" wood
<b>HTH6</b>	6 lbs.	16" wood

\* To promote even wear, fiberglass handle not recommended for this hammer. See our Trow & Holden Guide to Hammers.

## CARBIDE TRIMMING HAMMERS

Our most popular hammers are available with carbide on all edges, so you can use them longer with less regrinding. When blades eventually dull, turn the head over on the handle for two fresh edges. They work equally well for right or left hand use. Resharpener is easy on small grinders with 6" or 8" diameter silicon carbide wheels.

	WEIGHT	HANDLE LENGTH*
<b>HTH2BCT/V</b> with Carbide Blade & Concave Carbide Face	2 lbs.	16" wood
<b>HTH2BCT/H</b> with Horiz. Concave Face & Carbide Blade	2 lbs.	16" wood
<b>HTH212CT/V</b> with two Concave Carbide Faces	2-1/2 lbs.	16" wood
<b>HTH212CT/H</b> with two Horizontal Concave Faces	2-1/2 lbs.	16" wood
<b>HTH312CT/V</b> with two Concave Carbide Faces	3-1/2 lbs.	16" wood
<b>HTH312CT/H</b> with two Horizontal Concave Faces	3-1/2 lbs.	16" wood

\* To promote even wear, fiberglass handle not recommended for this hammer. See our Trow & Holden Guide to Hammers.

## THIN STONE VENEER TRIMMING HAMMER

This dual-purpose trimming hammer features a 1-1/4" carbide-tipped trimming blade that is offset and angled to optimize stone cutting performance when trimming fragile thin stone. The hardened striking face can be used for striking light hand tools to efficiently achieve the "hand cut" look. For maximum trimming control, use with the Thin Stone Veneer Hardie (page 24). Fiberglass handle available at additional cost.

	WEIGHT	HANDLE LENGTH
<b>HTSV2CT</b>	2 lbs.	12" wood or 13" fiberglass

## MALLORCAN HAMMERS

Perfect for pointing, shaping, texturing and trimming, the Mallorcan hammer features a round, dimpled recess on the trimming head which makes it easier to grind nice, sharp edges on all sides. This face is also slightly angled, allowing for better contact and clearance when using the top edge. Fiberglass handle available at additional cost.

	WEIGHT	HANDLE LENGTH
<b>HLL2</b>	2 lbs.	16" wood or 16" fiberglass
<b>HLL3</b>	3 lbs.	30" wood or 32" fiberglass
<b>HLL4</b>	4 lbs.	30" wood or 32" fiberglass

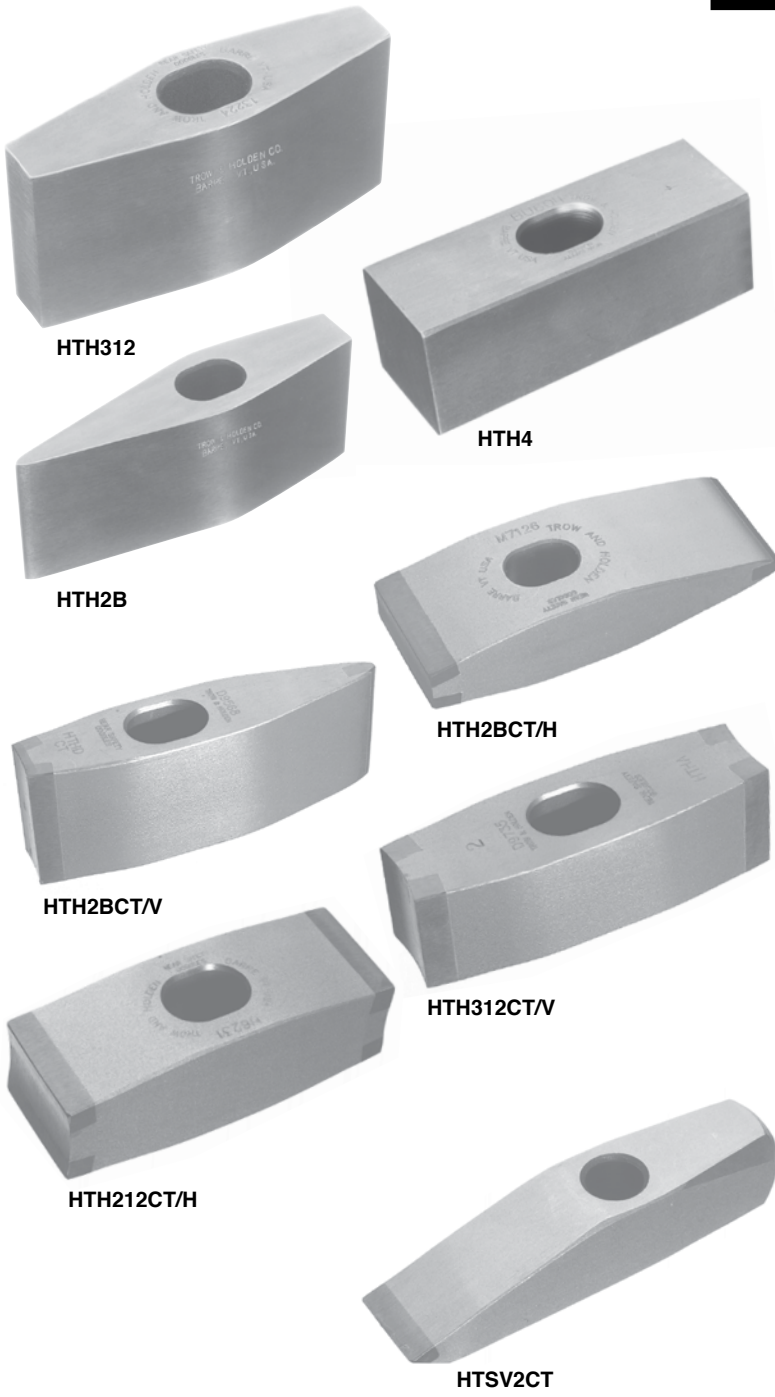

## ROUND HAND HAMMERS

The curved surface of our Round Hand Hammer makes it easier to deliver an accurate blow every time, without fear of a mis-strike! These hammers are medium hard for smaller chisels and finer work. Includes 7" round hardwood handle.

## BRASS HAMMERS

Brass Hammers are perfect for lettering or other light work. Softer metal helps prevent bruising of the stone and reduces chisel shank wear. The round head means the hammer makes contact wherever it strikes the chisel, reducing the chance of mis-strikes. Includes 7" round hardwood handle.

ROUND HAND HAMMER	WEIGHT	BRASS HAMMER
HCHR1	1 lb.	HBR1
HCHR112	1-1/2 lbs.	HBR112





## SOFT STONE HAMMER

This annealed (or unhardened) hammer produces a lighter blow, which can provide more control when working in softer stone. Excellent for lettering and detailing work, the Soft Stone Hammer is also less likely to bruise the stone.

	WEIGHT	HANDLE INCLUDED
HCH112SS	1-1/2 lbs.	12" wood

## CARBIDE MOSAIC HAMMERS

Used to cut tile for detailed mosaic work, the Carbide Mosaic Hammer has two fine blades for making delicate cuts. Available in 1 lb. and 2-1/2 lb. weights with steel or carbide blades, or a combination of the two. Use in conjunction with the steel Hardie. 12" wood handle included.

	WEIGHT	HANDLE INCLUDED
 HMO1 Steel	1 lb.	12" wood
 HMO212 Steel	2-1/2 lbs.	12" wood
HMO1CT Carbide	1 lb.	12" wood
HMO212CT Carbide	2-1/2 lbs.	12" wood
 HMO1CT/DB Combo	1 lb.	12" wood
 HMO212CT/DB Combo	2-1/2 lbs.	12" wood

## MOSAIC HARDIE

A must for mosaic work, the pointed end of the Mosaic Hardie is designed to be driven into a block of wood. The hardened chisel edge allows for precise placement and cutting of glass, tile, wood or other mosaic materials.

# TOOL MAINTENANCE

For more information about carbide tool care, see our Tech Tip on page 8.

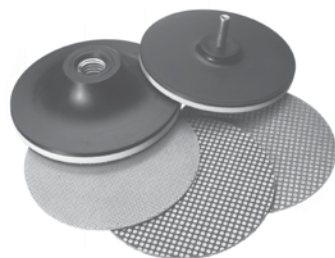

## BACKPLATES & DIAMOND PADS

Diamond is an ideal material for re-grinding carbide blades because it is one of the few materials that is actually harder than carbide. Use the 4" Velcro-mounted diamond pad with backplate for quick, almost effortless touch-ups. Start with a 120 grit pad, then finish with a 220 grit (other grits are also available). The backplate is available with threading to mount on an angle grinder, or with a 1/4" mandrel for use with a drill.

### BACKPLATES

- P0401** - 4" with 5/8-11 threading
- P0410** - 4" with 1/4" mandrel

### DIAMOND PADS

- G4101** - 4" 70 grit
- G4102** - 4" 120 grit
- G4103** - 4" 220 grit

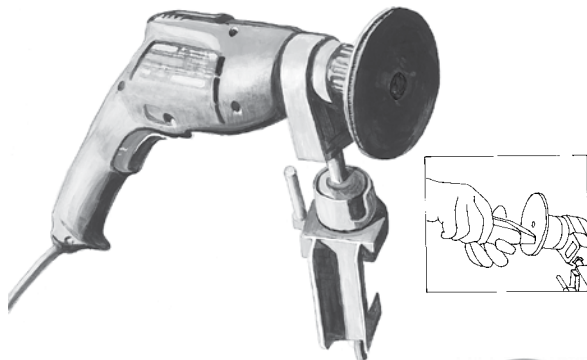

## SWIVEL SHARPENING SYSTEM

The Swivel Sharpening System includes a steel swivel clamp, drill, backplate and two diamond sharpening pads, 120 grit and 220 grit. It offers an adjustable, secure and convenient mounting system which is secured to your base for safest possible operation. The swivel head maintains its position for the most effective usage.

## SILICON CARBIDE SHARPENING WHEEL

An 80 grit silicon carbide grinding wheel (also known as a "green wheel") is an alternative to diamond pads for regrinding carbide blades. Use with a 6" or 8" bench grinder. Wheel width is 1" and arbor is 1" in diameter (adaptors available).



### SILICON CARBIDE SHARPENING WHEEL

- SSGC80611** - 6"                      **SSGC80811** - 8"

# REPLACEMENT HAMMER HANDLES

All wood handles are sourced from U.S. suppliers in the highest-grade hickory available. Wood replacement handles will ship with wood and steel shims for proper installation. Wood handles may require sanding for proper fit. Fiberglass handle kits are supplied by Nupla, a leading U.S.

manufacturer of fiberglass handles. All kits include a handle and epoxy. Handle lengths refer to overall length of uninstalled handle. Installed length will be slightly shorter. For more information about handle selection, please refer to the hammer section on our website.

	HANDLE DESCRIPTION*	HAMMER COMPATIBILITY
<b>HA-RND</b>	7" wood (round)	1-2 lb. Round Eye Hand Hammers
<b>HA-RP24</b>	12" wood	24 oz. Rock Picks, Mosaic, Veneer, 1-1/2 lb. Bushing Hammers, 18 oz. Paleo Hammer, 18 oz. Geo Pick
<b>HA-12OE</b>	12" wood	2-4 lb. Oval Eye Hand Hammers
<b>HA-13</b>	13" wood (round)	1-4 lb. Round Eye Hand Hammers
<b>HA-#13 or HA-#13SG</b>	13" smooth fiberglass or 13" special grip fiberglass	Hand Hammers, Hammer Points, Mosaic, Veneer, 18 oz. Paleo Hammer, 18 oz. Geo Pick
<b>HA-14</b>	14" wood (round)	2-4 lb. Bell Hammers
<b>HA-#14SG</b>	14" fiberglass	2-4 lb. Bell Hammers

	HANDLE DESCRIPTION*	HAMMER COMPATIBILITY
<b>HA-15</b>	15" wood	22 oz. Paleo Hammer and Geo Pick
<b>HA-16</b>	16" wood	2-6 lb. Stone Hammers
<b>HA-#16 or HA-#16SG</b>	16" smooth fiberglass or 16" special grip fiberglass	2-6 lb. Stone Hammers, 22 oz. and 28 oz. Paleo Hammer, 22 oz. and 28 oz. Geo Pick
<b>HA-17</b>	17" wood	28 oz. Paleo Hammer and Geo Pick
<b>HA-30</b>	30" wood	8-12 lb. Stone Hammers
<b>HA-32</b>	32" heavy wood	14-20 lb. Stone Hammers
<b>HA-#32</b>	32" fiberglass	8-20 lb. Stone Hammers

\* All handles are for oval eye unless otherwise specified.

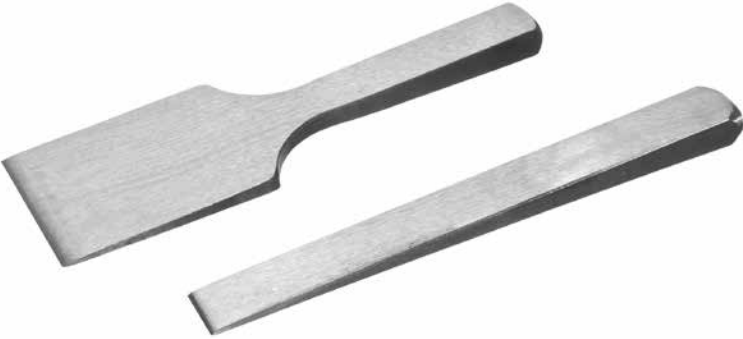

# TOOLS FOR FOSSIL HUNTING

Our new line of tools for fossil hunting will enhance the experience for professionals and newcomers alike. Our field research, along with lots of feedback from experts, allowed us to develop tools that are sturdy, versatile and lightweight, reducing your load when long treks are part of your exploration.



## SLATE SPLITTERS

Originally designed for use in the slate industry, the Slate Splitter has proven to be a superior tool for the splitting of fossil-containing stone of all kinds. The tool's fine taper and sharp edge give you the ability to cleave sedimentary stone cleanly and easily along its grain. Even limestone that can be difficult to split with conventional tools is no match for the Slate Splitter.

	BLADE	OVERALL LENGTH
 <b>SLSP1</b>	1" wide	9"
<b>SLSP2</b>	2" wide	9"
 <b>SLSP212</b>	2-1/2" wide	9"
 <b>SLSP3</b>	3" wide	9"

Also shown on page 24.



## GEO PICKS

The Geo Pick features a hardened steel point perfectly suited for breaking apart rock. The other end can be used to strike a chisel or can be struck with another hammer. The Geo Pick is a workhorse when it comes to both fossil hunting and more general rockhounding work. It is especially useful when working with stone that does not readily split along the grain.

	WEIGHT	HANDLE LENGTH
<b>HGP18</b>	18 oz.	12" wood or 13" fiberglass
<b>HGP22</b>	22 oz.	15" wood or 16" fiberglass
<b>HGP28</b>	28 oz.	17" wood or 16" fiberglass



## PALEO HAMMERS

Designed specifically for fossil work, the Paleo Hammer features a hardened steel blade and a striking head. This multipurpose tool is ideal for splitting apart shale and limestone, striking hand tools, and can also be struck with another hammer. Handles are available in hickory and fiberglass, both of which offer substantially better shock absorption than forged handles.

	WEIGHT	HANDLE LENGTH
<b>HPS18/H</b>	18 oz.	12" wood or 13" fiberglass
<b>HPS22/H</b>	22 oz.	15" wood or 16" fiberglass
<b>HPS28/H</b>	28 oz.	17" wood or 16" fiberglass



## BELL HAMMERS

The Bell Hammer offers several advantages over the conventional hand sledge. The round striking surface makes it possible to deliver a solid blow without the need to square it up with your chisel, while the head's shape makes the hammer easy to store and access.

	WEIGHT	HANDLE LENGTH
<b>HBB2</b>	2 lbs.	14" wood or 14" fiberglass
<b>HBB212</b>	2-1/2 lbs.	14" wood or 14" fiberglass
<b>HBB3</b>	3 lbs.	14" wood or 14" fiberglass
<b>HBB312</b>	3-1/2 lbs.	14" wood or 14" fiberglass
<b>HBB4</b>	4 lbs.	14" wood or 14" fiberglass

Also shown on page 26.

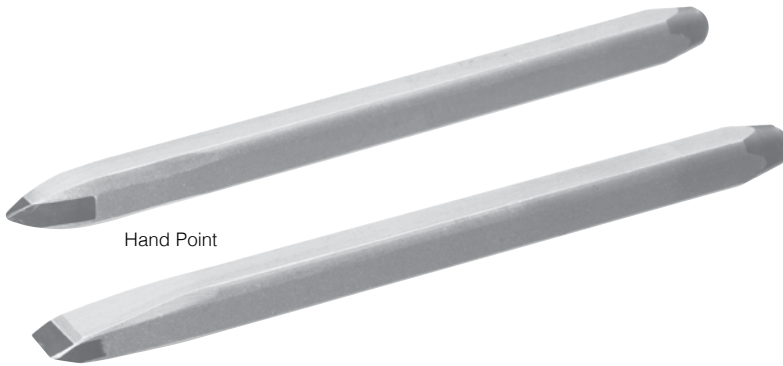

Hand Point

Hand Chisel

## CARBIDE HAND POINTS & HAND CHISELS

Use the Hand Point and Hand Chisel for more precise removal of stone, and for careful extraction of specimens from the surrounding rock. The carbide tips make these tools especially useful when working in harder types of stone.

HAND POINT	STOCK	HAND CHISEL
<b>CHP38</b>	3/8"	<b>CHC38</b>
<b>CHP12</b>	1/2"	<b>CHC12</b>

Also shown on page 16.

## TROW & HOLDEN FOSSIL HUNTING SET | A Great Value!

### FOSSIL HUNTING SET

Initial feedback on our new set for fossil hunters has been nothing short of ecstatic. Whether you're just beginning to explore the world of fossil collecting or are an expert looking to upgrade your gear, this set includes a variety

of essential tools and accessories. A choice between the Paleo Hammer or Geo Pick in different weights allows you to customize the set based on the type of stone you are working with.



CHOICE OF HAMMERS  
GEO PICK OR PALEO HAMMER

Set includes:

- Your choice of Paleo Hammer or Geo Pick, in one of three sizes: 18 oz., 22 oz., or 28 oz.
- 2 lb. Bell Hammer for striking other tools
- 1" and 2" Slate Splitter chisels, 1/2" Carbide Hand Chisel, and 1/2" Carbide Hand Point
- Canvas Tool Wrap for easy storage
- Safety glasses
- T&H branded Karst Stone Paper field notebook
- Optional "Guide for Beginning Fossil Hunters" at no charge

# TOOLS FOR ROCKHOONDING

Whether you are mining for gemstones, hunting for fossils, or just smashing rocks in your backyard to see what's inside, the performance of our rockhounding tools is unmatched. Find out why one rockhound thinks these tools "should be the new industry standard."

## CARBIDE HAMMER POINT

Perfect for aggressive removal of stone from a targeted area, and for striking other tools and hammers. See page 29.



## STONE BUSTER

A versatile carbide-tipped hammer that is great for breaking apart rocks, large and small. Available in 2 lb. and 4 lb. weights; see page 29.



## GEO PICK

Designed to efficiently chip away at rock and facilitate removal of specimens from the matrix. Can also be struck with another hammer or used to strike hand tools. See page 34.



## PALEO HAMMER

Designed to split sedimentary stone along its grain. Can also be struck with another hammer or used to strike hand tools. See page 34.



## QUARRY BUSTER

When nothing but brute force will do, this hardened steel powerhouse makes the most of its considerable heft. Available in 10, 12 and and 14 lb. weights; see page 27.



## BELL HAMMER

Rockhounds everywhere are falling in love with this versatile hand hammer. Use it to strike hand tools or wedges and shims. See page 26.



## HAND WEDGES

A wide assortment of wedges for exploiting existing cracks of all sizes. See page 38.

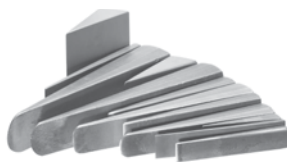

## SLATE SPLITTERS

Split sedimentary stone with precision and ease. See pages 24 and 34.



## CARBIDE HAND POINTS & CHISELS

For precise removal of stone and careful extraction of specimens. See pages 16 and 35.



## SLEDGE WEDGES

These sturdy, hardened wedges are flat on the bottom. Strike at ground level to create an opening where there is a stone shelf. See page 38.

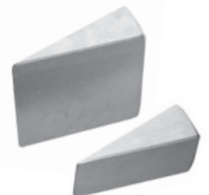

## WEDGES & SHIMS

Can be used to split stone of virtually any size. See page 38.



## HAND PLUG DRILLS

Use to drill holes for Wedges & Shims when power tools are not an option. See page 38.



# TOOLS FOR LIMESTONE

Limestone has unique characteristics, calling for chisels that are both strong and sharp. Our steel Limestone Chisels are hardened for durability and feature sharpened blades for efficiency and precision. Carbide chisels are beveled to deter breakage and can be used for more aggressive material removal.

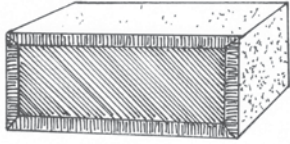

Droving Chisel effect on limestone

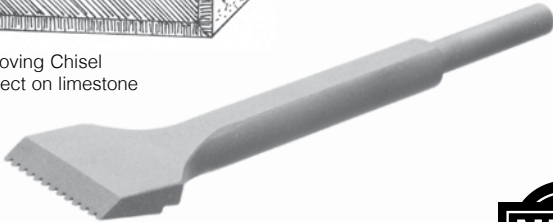

## LIMESTONE DROVING CHISELS

Whether you are restoring an existing finish or creating a new one, our pneumatic Limestone Droving Chisel allows you to carve parallel lines quickly and precisely into limestone and other soft stone.

	STOCK	SHANK	WIDTH OF BLADE
AL5812D112	5/8"	1/2"	1-1/2"
AL5812D2	5/8"	1/2"	2"



## LIMESTONE PITCHING TOOLS

Our Limestone Pitching Tool is similar to our Offset Hand Set but with a finer taper and thinner blade that offer a greater degree of control when trimming or shaping limestone and other soft stone.



	STOCK	WIDTH OF BLADE
AHOL78112	7/8"	1-1/2"
AHOL782	7/8"	2"
AHO78212	7/8"	2-1/2"



## LIMESTONE HAND CHISELS

Featuring a finely tapered blade and an 8-1/4" length, our Limestone Hand Chisels offer an unrivaled degree of control. The 5/8" octagonal shape of the stock fits comfortably in the hand while providing a solid grip that makes the most of the tool's sharp edge. Available in steel or carbide. Steel chisels available with tooth or rondel blade.

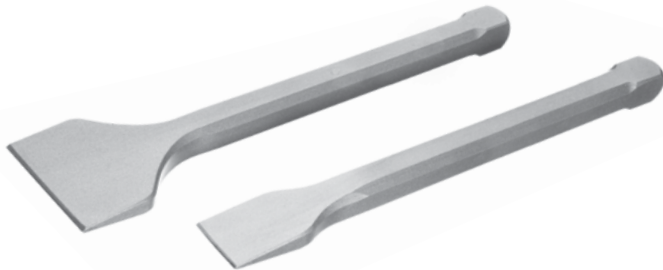

CARBIDE	STOCK	WIDTH OF BLADE	STEEL
CHCL34	5/8"	3/4"	AHCL34
CHCL1	5/8"	1"	AHCL1
CHCL112	5/8"	1-1/2"	AHCL112
CHCL2	5/8"	2"	AHCL2

## LIMESTONE MACHINE CHISELS

Used with a Trow & Holden air hammer, these chisels feature a finely tapered blade sharpened for optimal effectiveness when used on limestone. Available in steel or carbide. Steel chisels available with tooth or rondel blade. See page 7.



## FLARED CHISELS

Access hard-to-reach places when sculpting in softer stone with these steel Flared Chisels. See page 22.

# SPLITTING EQUIPMENT

## WEDGES & SHIMS

Minimum hole depth must be 1/4" or more longer than Wedge length.

HOLE DIAMETER	WEDGE LENGTH
3/8"	2-1/2"
1/2"	2-3/4"
5/8"	3"
3/4"	4"
7/8"	5"
1"-1-1/8"	6"
1-1/4"-1-3/8"	8"
1-1/2"-1-3/4"	AVAIL. IN 5 HOLE DEPTHS:
	12"
	18"
	24"
	36"
	48"
2"+	12"

Available with round shanks for use with drills or breakers. Please specify shank size required.

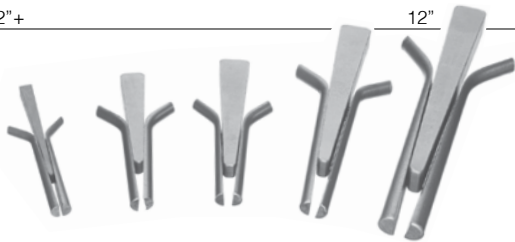

### TROW & HOLDEN TECH TIP

## WEDGES & SHIMS (or plugs and feathers)

With the proper technique, the use of Wedges and Shims remains one of the most effective and efficient methods of splitting most types of stone. Here's how to use them:

1. The height of your stone determines W&S size required. W&S can split up to 4-6 times the length of the Wedge (e.g., 4" W&S can split a stone 16-24" high/thick).

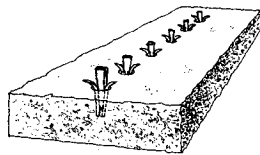

2. Holes should always be drilled to the specified diameter, 4-6" apart on center, and at least 1/4" deeper than the length of the Wedge (e.g., 3/4" W&S require a 3/4" diameter hole, 4-1/4" deep). For more difficult splits, drill holes deeper and closer together.

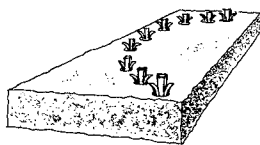

3. Insert W&S into holes as shown. Make sure the "ears" of the shims sit just above the top of the hole and perpendicular to the split line. About 2/3 of the length of the Wedge should also protrude from the top of the hole.

4. Once set, start striking the Wedges in sequence with a light hammer, firmly but without forcing, to build even pressure gradually. For difficult splits, allow the stone to rest occasionally. Listen and look for signs of splitting. Repeat until stone splits.

## HAND PLUG DRILLS

For drilling holes in stone by hand. Simply rotate between strikes.

	DIAMETER OF BIT END
AHPD58-R	5/8"
AHPD34-R	3/4"

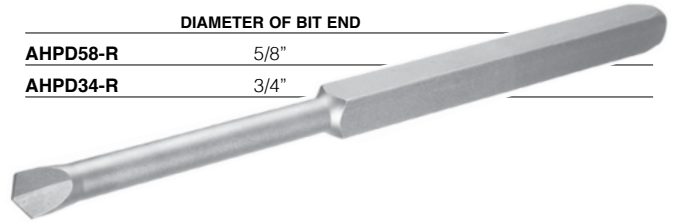

## SDS ADAPTORS

Modify your SDS drill bits for hand use by sliding our adaptor over the shank. It protects the shank for future use with a power drill. Fits SDS PLUS or MAX drill bits.

SDS PLUS ADAPTOR

SDS MAX ADAPTOR

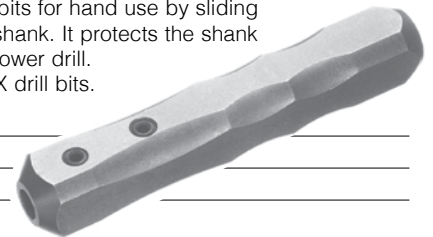

## HAND SPLITTING WEDGES

Split stone without drilling by driving these wedges into natural cracks and seams. They are most suitable for splitting softer stone or stone that has a seam in it. Specially heat-treated, the heads are hardened for impact resistance while the blades are hardened for wear.

Many standard sizes are available.

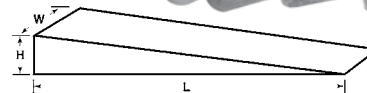
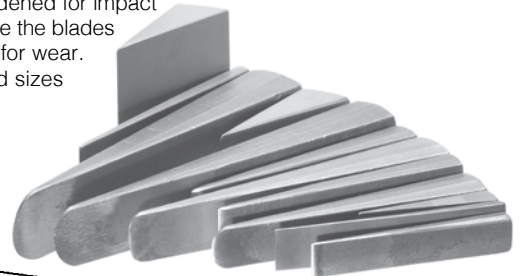

	H (Thickness at head)	W (Width)	L (Length)	BLADE THICKNESS	BLADE STYLE
HW1	1/4"	1-1/4"	6"	1/32"	Hand Wedge
HW2	1/2"	2"	8"	1/8"	Hand Wedge
HW5	1/2"	1"	6"	1/32"	Hand Wedge
HW6	3/4"	1-1/4"	4"	1/8"	Hand Wedge
HW7	3/4"	1-1/2"	8"	1/32"	Hand Wedge
HW8	1"	1-1/2"	8"	1/32"	Hand Wedge
HW13	1-3/4"	2"	5"	1/32"	Small Sledge Wedge
HW14	1-3/4"	4"	5"	1/32"	Large Sledge Wedge
HW15	1-1/4"	1-1/4"	8"	1/32"	Square Hand Wedge
HW16	1-1/2"	1-1/2"	10"	1/32"	Square Hand Wedge
HW17	1-3/4"	1-3/4"	12"	1/32"	Square Hand Wedge
HW18	2"	2"	12"	1/32"	Square Hand Wedge



# HEAVY DUTY DRILLS & HAMMERS

## ELECTRIC HAMMER DRILLS



Bosch rotary hammer drills can be used as a hammer drill or chipping hammer. For smaller holes (3/8" to 3/4"), the SDS Plus style drill is lighter and easier to control, at a good value. For maximum drilling performance up to 1-1/2" hole diameters, choose the SDS Max style.

DRILL STYLE	WEIGHT	VOLTS/AMPS	SHANK STYLE
<b>SDS-MAX</b>	15 lbs.	120V/13 A	SDS-MAX
<b>SDS-PLUS</b>	7 lbs.	120V/7.5 A	SDS-PLUS

### SDS-MAX BITS

<b>HC5010</b> - 1/2"	<b>HC5020</b> - 5/8"	<b>HC5030</b> - 3/4"	<b>HC5040</b> - 7/8"
<b>HC5050</b> - 1"	<b>HC5060</b> - 1-1/8"	<b>HC5070</b> - 1-1/4"	<b>HC5091</b> - 1-1/2"

### SDS-PLUS BITS

<b>HC2061</b> - 3/8"	<b>HC2081</b> - 1/2"	<b>HC2102</b> - 5/8"	<b>HC2122</b> - 3/4"
----------------------	----------------------	----------------------	----------------------

## SULLAIR ROCK DRILL



The Sullair MRD-9 Rock Drill weighs only 9 lbs. and is perfect for high volume drilling of holes up to 7/8."

SHANK SIZE	WEIGHT	AIR REQ'D	AIR HOSE
<b>CP-9</b>	9 lbs.	21 CFM	3/8"

## CARBIDE HOLLOW PLUG DRILLS

(FOR USE WITH PNEUMATIC ROCK DRILLS)



7/8" x 4-1/4" HEX SHANK		CP-9 SHANK (for Sullair)	
BIT DIA	DRILL DEPTH	BIT DIA	DRILL DEPTH
--	--	<b>X90212</b>	1/2" 8"
<b>X31216</b>	5/8" 6"	<b>X90116</b>	5/8" 8"
<b>X31219</b>	3/4" 6"	<b>X90119</b>	3/4" 8"
<b>X31322</b>	7/8" 9"	<b>X90122</b>	7/8" 8"
<b>X31325</b>	1" 9"	<b>X90125</b>	1" 8"
<b>X31328</b>	1-1/8" 9"	<b>X90128</b>	1-1/8" 8"

Other bit sizes (up to 1-1/2" dia.) and different drill depth lengths (up to 26" long) are available for both 7/8" Hex Shank and CP-9 Shank Drills. Call for price and availability.

# ACCESSORIES & APPAREL



## TOOL WRAPS

Both our leather and our canvas Tool Wraps are made by hand here in Vermont. The leather wrap is crafted from domestically-sourced hides and embossed with the Trow & Holden logo.

	SIZE
<b>TOOL WRAP/LEATHER</b>	26" l. x 14" h. with two ties & 10 pockets
<b>TOOL WRAP/CANVAS</b>	25" l. x 14" h. with no ties & 12 pockets (not shown)

## HAT

Keep stone dust out of your hair! Trow & Holden logo is embroidered on the front, with "Stone Cutting Tools" on the back. Adjustable leather closure. Ask about available colors.



## PINT GLASSES

These 16 oz. heavy glasses are perfect for your favorite beverage and are guaranteed to feel great in your hand — especially after a long day of holding onto a hammer and chisel! Sold in pairs only.



## T-SHIRT

All-cotton t-shirts with our logo on the front and "Stone Cutting Tools" on the back are available in men's sizes M-XXL. Ask about available colors.



## CANVAS TOOL BAG

Our heavy-duty tool bag is made from 100% cotton canvas, with interior pockets and mesh outer pockets. It features a reinforced wide-mouth opening, hard bottom, and padded canvas handles. 12" w. x 8-1/2" h.



## LEATHER TOOL BAGS

Handmade in Vermont from domestically-sourced hides, these rugged bags feature reinforced handles, solid brass hardware, and leather interior loops for keeping carbide-tipped hand tools securely stored. Each bag is individually cut and stitched, then hot-branded with the Trow & Holden logo. The character of these rugged tool bags increases with every passing season of use. And just like our tools, these bags will last and last.

	SIZE
<b>SMALL</b>	7" l. x 8-3/4" h. x 7" w.
<b>LARGE</b>	18" l. x 10" h. x 7-1/2" w.





## Guaranteed Craftsmanship & Quality Service

### Manufacturer's Warranty

Trow & Holden's chisels, hammers, and pneumatic tools are unconditionally guaranteed against defects in manufacturing and materials.

Under this guarantee, Trow & Holden will repair or replace, free-of-charge, any Trow & Holden tool evaluated and found to be defective. **However, please note that damage as a result of normal wear, misuse, mishandling, or failure to correctly maintain a tool**

**may not be covered under this guarantee.** For more detailed instruction on proper tool care, please review our respective tool guides in the References section of [www.trowandholden.com](http://www.trowandholden.com).

If you believe your tool has a manufacturing or materials defect, please contact Trow & Holden immediately. **Never use a tool if there is a question about its condition or performance.**

### Tool Return, Repair & Exchange Policies

Trow & Holden is committed to providing the information and service necessary for customers to purchase and maintain the optimal tool for their work. For assistance or to coordinate a return, please contact customer service at **800-451-4349** or via email at [info@trowandholden.com](mailto:info@trowandholden.com).

Below, please find an overview of our primary policies pertaining to tool returns, exchanges and repairs:

#### Returning Unused Merchandise

Unused tools may be returned for a full refund or credit within 30 days of the purchase date. However, any returned products that appear to be used or have not been kept in like-new condition may be subject to partial credit or restocking fees. There is a 25% re-stocking fee on returned tooth chisels except when purchased as part of a tool set.

#### Warranty Repair or Replacement

Tools being returned for service under warranty are subject to an evaluation upon arrival. Any tool that appears to have been damaged as a result of defect or irregularity will be replaced or repaired at no charge. Please contact customer service prior to any tool return, which will allow any necessary notes or arrangements to be made before the arrival of your tool.

#### General Maintenance, Repairs & Retip Exchanges

Any tool that is worn or has become damaged during the course of normal usage can be sent in for maintenance or repair. An assessment of the tool's condition will be made upon arrival, and service charges will be quoted accordingly. Tools that have been worn or damaged beyond reasonable repair will be eligible for Retip Exchange Pricing, which grants 15% off the price of a replacement tool.

### Custom Fabrication & Tool Modification

At Trow & Holden, we make an effort to maintain a collaborative relationship with our customers. If you need a specialized tool to suit a particular task, our craftsmen will work with you to fabricate, modify, or adapt a tool to make it just right. To make a custom tool inquiry or have an existing tool modified,

please contact us by phone or by email at [info@trowandholden.com](mailto:info@trowandholden.com). It may be helpful to supply a sketch illustrating rough shape and dimensions, as well as an explanation of the tool's usage. **Please note that our Manufacturer's Warranty may not apply to custom fabricated or altered tools.**

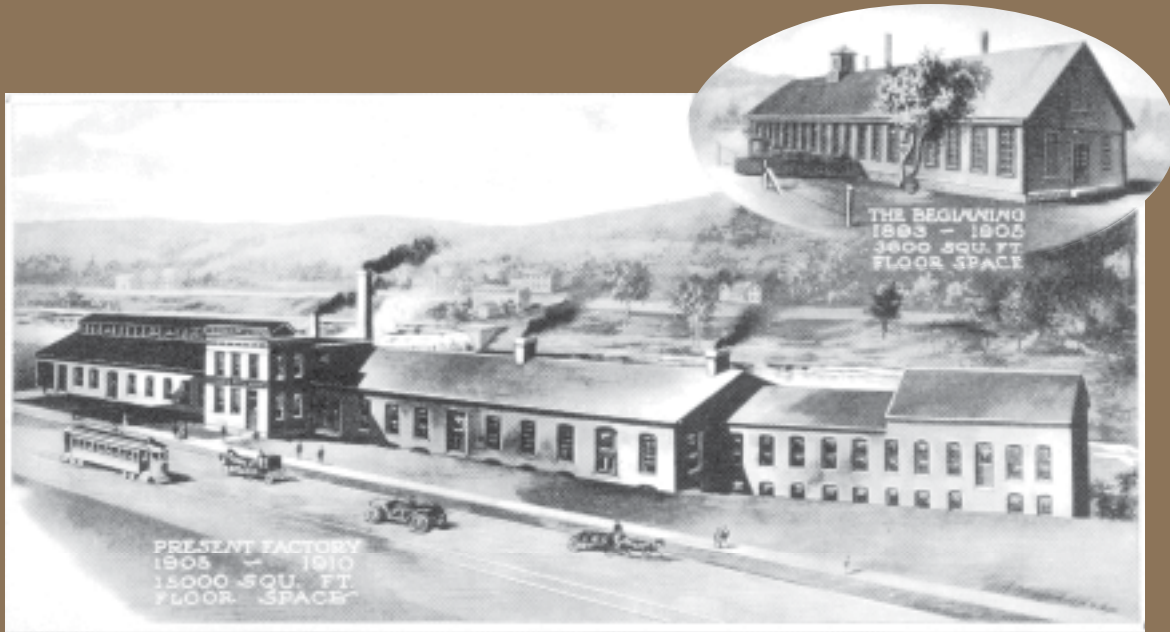

**TROW & HOLDEN COMPANY**  
FINE STONWORKING TOOLS

45 South Main Street • Barre, Vermont 05641  
phone 802-476-7221 • fax 802-476-7025  
1-800-451-4349 • [www.trowandholden.com](http://www.trowandholden.com)  
Follow us on Facebook

